

User Manual

SONO-VARIO Standard/Xtrem

SONO-VARIOStandard for general fine Bulk Goods like Sand

SONO-VARIOXtrem for very high abrasive Goods like Gravel/Grit



User Manual for SONO-VARIO Standard/Xtrem

Thank you for buying an IMKO moisture probe.

Please carefully read these instructions in order to achieve best possible results with your SONO-VARIO probe for the in-line moisture measurement. Should you have any questions or suggestions regarding your new probe after reading, please do not hesitate to contact our authorised dealers or IMKO directly. We will gladly help you.

List of Content:

1. Instrument Description SONO-VARIO	4
1.1.1. The patented TRIME® TDR-Measuring Method.....	4
1.1.2. TRIME® compared to other Measuring Methods	4
1.1.3. Areas of Application with SONO-VARIOStandard and SONO-VARIOXtrem	4
1.2. Mode of Operation	5
1.2.1. Measurement value collection with pre-check, average value and filtering.....	5
1.2.2. Determination of the mineral concentration with EC-TRIME	5
1.2.3. Material Temperature Measurement.....	5
1.2.4. Temperature compensation of the internal SONO-electronic.....	5
1.2.5. Analogue Outputs.....	6
1.2.1. The serial RS485 and IMP-Bus interface.....	7
1.2.2. The IMP-Bus as a user friendly network system.....	7
1.2.3. Error Reports and Error Messages	7
2. Configuration of the Measure Mode	8
2.1. Cyclic operation modes CA, CF, CH, CC and CK.....	8
2.1.1. <i>Average Time</i> in the measurement mode CA and CF	10
2.1.2. Filtering at material gaps in mode CA and CF	10
2.1.3. Mode CC – automatic summation of a moisture quantity during one batch process.	11
2.1.4. Mode CH – Automatic Moisture Measurement in one Batch	13
2.2. Overview of single modes for different applications	13
3. SONO Probes for measuring Moisture of Sand and Aggregates	14
3.1. SONO probes in use with different sand grading ranges	15
4. Calibration Curves	17
4.1. A calibration curve for “sand drying”	17
4.2. Creating a linear Calibration Curve for a specific Material	20
4.2.1. Calculation for a linear 2-point calibration curve	20
4.2.2. Calculation for a linear 1-point calibration curve	21
4.2.3. Calculation for a non-linear calibration curve	21
5. Connectivity to SONO Probes	22
5.1. Connection Plug and Plug Pinning	23
5.2. Analogue Output 0..10V with a Shunt-Resistor.....	24
5.3. Connection Diagram with the Display Module SONO-VIEW	24

6. Installation of the Probe	25
6.1. Further important Assembly Instructions.....	26
6.2. Use of the highly wear-resistant slider	28
6.3. Protection of the probe´s connector against splashing water	29
6.4. Assembly Dimensions	30
6.5. What to do if the Material Flow is not optimal?	32
6.5.1. Installation of SONO-VARIO in a vibration chute	32
6.6. Mounting in curved Surfaces.....	33
6.7. Gas- and waterproofed Installation in a Tube or Container	33
6.8. What should be done if the moisture values of the SONO-VARIO does not fit?	34
6.9. Exchange of the Probe Head of the VARIOxtrem	35
6.9.1. Basic Balancing of a new Probe Head.....	36
7. Serial Connection to the SM-USB Module from IMKO	37
8. Quick Guide for the Commissioning Software SONO-CONFIG	39
8.1.1. Scan of connected SONO probes on the serial interface	39
8.1.2. Configuration of serial SONO-interface	40
8.1.3. Set analogue outputs of the SONO probe	40
8.1.4. Configuration of Measure Mode.....	41
8.1.5. Setting the precision of a single value measurement cycle	42
8.1.6. Selection of the individual Calibration Curves	43
8.1.8. Test run in the respective Measurement Mode	44
8.1.9. “Measure” Run in Datalogging-Operation	44
8.1.10. Basic Balancing in Air and Water	45
8.1.11. Offsetting the material temperature sensor	46
8.1.12. Compensation of the electronic temperature	46
9. Technical Data SONO-VARIO	47
10. Savety Notes	49

1. Instrument Description SONO-VARIO

1.1.1. The patented TRIME® TDR-Measuring Method

The TDR technology (Time-Domain-Reflectometry) is a radar-based dielectric measuring procedure at which the transit times of electromagnetic pulses for the measurement of dielectric constants, respectively the moisture content are determined.

SONO-VARIO consists of a high grade steel casing with a wear-resistant sensor head with ceramic window. An integrated TRIME TDR measuring transducer is installed into the casing. A high frequency TDR pulse (1GHz), passes along wave guides and generates an electro-magnetic field around these guides and herewith also in the material surrounding the probe. Using a new patented measuring method, IMKO has achieved to measure the transit time of this pulse with a resolution of 1 picosecond (1×10^{-12}), consequently determine the moisture and the conductivity of the measured material.

The established moisture content, as well as the conductivity, respectively the temperature, can either be uploaded directly into a PLC via two analogue outputs 0(4) ...20 mA or recalled via a serial interface.

1.1.2. TRIME® compared to other Measuring Methods

In contrary to conventional capacitive or microwave measuring methods, the TRIME® technology (Time-Domain-Reflectometry with Intelligent Micromodule Elements) does not only enable the measuring of the moisture but also to verify if the mineral concentration specified in a recipe has been complied with. This means more reliability at the production.

TRIME-TDR technology operates in the ideal frequency range between 600MHz and 1,2 GHz.

Capacitive measuring methods (also referred to as Frequency-Domain-Technology), depending on the device, operate within a frequency range between 5MHz and 40MHz and are therefore prone to interference due to disturbance such as the temperature and the mineral contents of the measured material. Microwave measuring systems operate with high frequencies >2GHz. At these frequencies, nonlinearities are generated which require very complex compensation. For this reason, microwave measuring methods are more sensitive in regard to temperature variation.

SONO probes calibrate themselves in the event of abrasion due to a novel and innovative probe design. This consequently means longer maintenance intervals and, at the same time, more precise measurement values.

The modular TRIME technology enables a manifold of special applications without much effort due to the fact that it can be variably adjusted to many applications.

1.1.3. Areas of Application with SONO-VARIO^{Standard} and SONO-VARIO^{Xtrem}

SONO-VARIO is suited for moisture measurement of different materials. An installation is possible into containers, hoppers, above conveyor belts, or in silos.

- The **SONO-VARIO^{Standard}** is suited for measuring of normal abrasive materials like sand and gravel up to 4mm. The probe head consists of stainless steel with a rectangular ceramic window.
- The **SONO-VARIO^{Xtrem}** is suited for measuring of very high abrasive materials like gravel 4/32 and grit. The probe head consists of oil hardened steel with a rectangular special ceramic window.

1.2. Mode of Operation

1.2.1. Measurement value collection with pre-check, average value and filtering

SONO probes measure internally at very high cycle rates of 10 kHz and update the measurement value at a cycle time of 280 milliseconds at the analogue output. In these 280 milliseconds a probe-internal pre-check of the moisture value is already carried out, i.e. only plausible and physically checked and pre-averaged single measurement values are used for the further data processing. This increases the reliability for the recording of the measured values to a downstream programmable control system PLC significantly.

In the **Measurement Mode CS** (Cyclic-Successive), an average value is not accumulated and the cycle time here is 200 milliseconds. In the **Measurement Mode CA, CF, CH, CC and CK**, not the momentarily measured individual values are directly issued, but an average value is accumulated via a variable number of measurements in order to filter out temporary variations. These variations can be caused by inhomogeneous moisture distribution in the material surrounding the sensor head. The delivery scope of SONO probes includes suited parameters for the averaging period and a universally applicable filter function deployable for currently usual applications. The time for the average value accumulation, as well as various filter functions, can be adjusted for special applications.

1.2.2. Determination of the mineral concentration with EC-TRIME

With the radar-based TRIME measurement method, it is now possible for the first time, not only to measure the moisture, but also to provide information regarding the conductivity, respectively the mineral concentration or the composition of a special material. Hereby, the attenuation of the radar pulse in the measured volume fraction of the material is determined. This novel and innovative measurement delivers a radar-based conductance value (EC-TRIME) in dS/m as characteristic value which is determined in dependency of the mineral concentration and is issued as an unscaled value. The EC-TRIME measurement range of the SONO probe is 0..12dS/m

1.2.3. Material Temperature Measurement

A temperature sensor is installed into the SONO-probe which establishes the casing temperature 3mm beneath the sensor surface. The temperature can optionally be issued at the analogue output². As the TRIME electronics operates with a power of approximately 1.5 W, the probe casing does slightly heat up. A measurement of the material temperature is therefore only possible to a certain degree. The material temperature can be determined after an external calibration and compensation of the sensor self-heating. The offset of the measured temperature value can be adjusted with help of the program SONO-CONFIG.

Despite SONO probes show a generally low temperature drift, it could be necessary to compensate a temperature drift in special applications. SONO probes offer two possibilities for temperature compensation.

Temperature compensation for the measured material

Water and special materials like oil fruits and others, can show a dependency of the dielectric permittivity when using SONO probes at high temperature ranges. The dielectric permittivity is the raw parameter for measuring water content with SONO probes. If special materials show a very special temperature drift, e.g. in lower temperatures a higher drift than in higher temperatures, than it could be necessary to make a more elaborate temperature compensation. Therefore it is necessary to measure in parallel the material temperature with the temperature sensor which is placed inside the SONO probe. Normally this is related with high efforts in laboratory works. SONO probes offer the possibility to set special temperature compensation parameters t_0 to t_5 for every calibration curve Cal1 of Cal15 (see chapter "Selection of the individual calibration curve"). Please contact IMKO should you need any assistance in this area.

1.2.4. Temperature compensation of the internal SONO-electronic

With this method of temperature compensation, a possible temperature drift of the SONO-electronic can be compensated. Because the SONO-electronic shows a generally low temperature drift, SONO probes are presetted at delivery for standard ambient conditions with the parameter **TempComp=0.2**. Dependent on SONO probe type, this parameter TempComp can be adjusted for higher temperature

ranges (up to 120°C for special version) to values up to **TempComp=0.75**. But it is to consider that it is necessary to make a Basic-Balancing of the SONO probe in air and water, if the parameter TempComp is changed to another value as TempComp=0.2. The parameter TempComp can be changed with the software tool SONO-CONFIG, in the menu "**Calibration**" and the window "**Electronic-Temperature-Compensation**".



Attention: When changing the TempComp parameter, a new basic balancing of the SONO probe is necessary!

1.2.5. Analogue Outputs

The measurement values are issued as a current signal via the analogue output. With the help of the service program **SONO-CONFIG**, the SONO probe can be set to the two versions for 0..20mA or 4..20mA. Furthermore, it is also possible to variably adjust the moisture dynamic range e.g. to 0-10%, **0-20%** or 0-30%. For a 0-10V DC voltage output, a 500R resistor can be installed in order to reach a 0..10V output.

Analogue Output 1: Moisture in % (0...20%, variable adjustable)

Analogue Output 2: Conductivity (EC-TRIME) or optionally the temperature.

In addition, there is also the option to split the analogue output 2 into two ranges: into 4..11mA for the temperature and 12..20mA for the conductivity. The analogue output two hereby changes over into an adjustable one-second cycle between these two (current) measurement windows.

For the analogue outputs 1 and 2 there are thus two adjustable options:

Analogue Output: (two possible selections)

0..20mA

4..20mA

For very special PLC applications, the current output can be inverted into:

20mA...0mA or **20mA...4mA**

Analogue Output Channel 1 and 2: The two analogue outputs of the SONO probe can be adjusted into one to four possible selections.

1. Moist, Temp	Analogue output 1 for moisture, output 2 for material temperature.
2. Moist, Conduct	Analogue output 1 for moisture, output 2 for conductivity in ranges of 0..20dS/mS or 50dS/m
3. Moist, Temp/Conductivity	Analogue output 1 for moisture, output 2 for both, temperature and conductivity (EC-TRIME) with an automatic current-window change in cycles of 5 seconds.
4. Moist / MoistSTdDev	Analogue output 1 for moisture, output 2 for the standard deviation based on the single moisture values. This function is useful in e.g. fluid bed drier for air volume control.

Adjustment for the Measurement Ranges

For analogue output 1 and 2 the moisture dynamic range and temperature dynamic range can be variably adjusted. The moisture dynamic range should not exceed 100%

Moisture Range:

Maximum: e.g. 20 for sand (Set in %)

Minimum: 0

Temp. Range:

Maximum: 70 °C

Minimum: 0 °C

Conductivity Range: 0..20dS/m or 0..50dS/m

Dependent on probe type and moisture range, SONO probes can measure pore water conductivities (EC-TRIME) in ranges of 5dS/m up to 50dS/m.

1.2.1. The serial RS485 and IMP-Bus interface

SONO-probes are equipped with a standard RS485 as well as the IMP-Bus interface to set and readout individual parameters or measurement values. An easy to implement data transfer protocol enables the connection of several sensors/probes at the RS485-Interface. In addition, SONO-probes can be directly connected via the module SM-USB or the display module SONO-VIEW to the USB port of a PC, in order to adjust individual measuring parameters or conduct calibrations.

Please consider: The initial default setting of the serial interface is pre-setted for the IMP-Bus. To operate with the RS485 inside the SONO-probe, it is necessary to switch and activate the RS485 interface with help of the modul SM-USB or SONO-VIEW.

In the **Support** area of IMKO's homepage www.imko.de we publish the transmission protocol of the SONO-probes.

1.2.2. The IMP-Bus as a user friendly network system

With external power supply on site for the SONO probes, a simple 2-wire cable can be used for the networking. By use of 4-wire cables, several probes can be also supplied with power.

Standard RS485-interfaces cause very often problems! The RS485 is usually not galvanically isolated and therefore raises the danger of mass grindings or interferences which can lead to considerably security problems. An RS485 network needs shielded and twisted pair cables, especially for long distances. Depending on the topology of the network, it is necessary to place 100Ohm termination resistors at sensitive locations. In practice this means considerable specialist effort and insurmountable problems.

The robust IMP-Bus ensures security. SONO-probes have in parallel to the standard RS485 interface the robust galvanically isolated IMP-Bus which means increased safety. The serial data line is isolated from the probe's power supply and the complete sensor network is therefore independent from single ground potentials and different grid phases. Furthermore the IMP-Bus transmit its data packets not as voltage signals, but rather as current signals which also works at already existing longer cables. A special shielded cable is not necessary and also stub lines are no problem.

1.2.3. Error Reports and Error Messages

SONO probes are very fault-tolerant. This enables failure-free operation. Error messages can be recalled via the serial interface.

2. Configuration of the Measure Mode

The configuration of SONO- probe is preset in the factory before delivery. A process-related later optimisation of this device-internal setting is possible with the help of the service program **SONO-CONFIG**. For all activities regarding parameter setting and calibration the probe can be directly connected via the serial interface to the PC with SM-USB-Module or the SONO-VIEW display module which are available from IMKO.

The following settings of SONO probes can be amended with the service program **SONO-CONFIG**:

Measurement-Mode and Parameters:

- Measurement Mode A-On-Request (only in network operation for the retrieval of measurement values via the serial interface).
- Measurement Mode C Cyclic:
SONO-VARIO is supplied ex-factory with suited parameters in **Mode CH** for measuring moisture of sand and gravel. For other applications, mode CA could be usable. Up to 6 different modes can be adjusted:

Mode CS: (Cyclic-Successive) For very short measuring processes (e.g. 2...10 seconds) without floating average and without filter functions, with internal up to 100 measurements per second and a cycle time of 250 milliseconds at the analogue output. Measurement mode CS can also be used for getting raw data from the SONO-probe without averaging and filtering.

Mode CA: (Cyclic-Average-Filter) For relative short measuring processes with continual average value, filtering and an accuracy of up to 0.1%

Mode CF: (Cyclic-Float-Average) for continual average value with filtering and an accuracy of up to 0.1% for very slowly measuring processes, e.g. in fluidized bed dryers, conveyor belts, etc.

Mode CK: (Cyclic-Kalman-Filter with Boost) Standard setting for SONO-MIX for use in fresh concrete mixer with continual average value with special dynamic Kalman filtering and an accuracy of up to 0.1%.

Mode CC: (Cyclic Cumulated) with automatic summation of a moisture quantity during one batch process.

Mode CH: (Cyclic Hold) similar to Mode CC but without summation.

Mode CH is recommended for applications in the construction industry. If the SONO-probe is installed under a silo flap, Mode CH can measure moisture when batch cycles are very short, down to 2 seconds. Mode CH executes an automatic filtering, e.g. if dripping water occurs.

- Precision of a single TDR radar pulse measurement (see in chapter „Software tool SONO-CONFIG“ under point „Setting the precision of a single value measurement“).

Each of these settings will be preserved after shut down of the probe and is therefore stored on a permanent basis.

2.1. Cyclic operation modes CA, CF, CH, CC and CK

For the cyclic modes the SONO probes are supplied ex-factory with suited parameters for the averaging time and with a universally deployable filter function suited for most currently applications.

The setting options and special functions of SONO probes depicted in this chapter are only rarely required. It is necessary to take into consideration that the modification of the settings or the realisation of these special functions may lead to faulty operation of the probe!

For applications with non-continuous material flow, there is the option to optimise the control of the measurement process via the adjustable filter values *Filter-Lower-Limit*, *Filter-Upper-Limit* and the time constant *No-Material-Keep-Time*. The continual/floating averaging can be set with the parameter *Average-Time*.

Parameters in the Measurement Mode CA, CF, CC, CH and CK	Function
Average-Time Standard Setting: 2s Setting Range: 1...20 Unit: Seconds	CA/CF: Time (in seconds) for the generation of the average value can be set with this parameter. CC/CH/CK: Setting of the time for calculation of the trend or expectation value for the Boost & Offset function.
Filter-Upper-Limit-Offset Standard Setting: 25% Setting Range: 1...20 Unit: % Absolut	CA/CC/CF/CH/CK: Too high measurement values generated due to metal wipers or blades are filtered out. The offset value in % is added to the dynamically calculated upper limit.
Filter-Lower-Limit-Offset Standard Setting: 25% Setting Range: 1...20! Unit: % Absolut	CA/CC/CF/CH/CK: Too low measurement values generated due to insufficient material at the probe head are filtered out. The offset value in % is subtracted from the dynamically calculated lower limit with the negative sign.
Upper-Limit-Keep-Time Standard Setting: 10 Setting Range: 1...100 Unit: % Absolut	CA/CC/CF/CH/CK: The maximum duration (in seconds) of the filter function for Upper-Limit-failures (too high measurement values) can be set with this parameter.
Lower-Limit-Keep-Time Standard Setting: 10 Setting Range: 1...100s Unit: Seconds	CA/CC/CF/CH/CK: The maximum duration (in seconds) of the filter function for Lower-Limit-failures (too low measurement values) for longer-lasting "material gaps", ie the time where no material is located on the probe's surface can be bridged.
Moisture Threshold (start threshold in %-moisture) Standard Setting: 0.1% Setting Range: 0...100% Unit: % Absolut	CA/CF/CK: inactive CC/CH: The accumulation of moisture values starts above the „Moisture Threshold“ and from here the analogue signal is outputted. The accumulation pauses and will be frozen if the moisture level is below the threshold value. The No-Material-Delay time starts and material gaps (disturbance) can be eliminated.
No-Material-Delay (period time) Standard Setting: 10s Setting Range: 1...100s Unit: Seconds	CA/CF/CK: inactive CC/CH: The accumulation stops if the moisture value is below the Moisture Threshold . The accumulation pauses for the period of the setted delay time and will be frozen if the moisture level is below the threshold value. The SONO probes starts again in a new batch with a new accumulation after the setted time span of the "No-Material-Delay" is completely exceeded.
Boost Standard Setting: 35nn Setting Range: 1...100nn Unit: without unit!	CA/CF: inactive CC/CH/CK: Defines, how strong single measurement values are weighted dependent on deviation to the current expected average value. With e.g. Boost=35, a single measurement value is weighted with only 65% (100-35) for a new average value.
Offset Standard Setting: 0.5% Setting Range: 0 ...5% Unit: % Absolut	CA/CF: inactive CC/CH/CK: Non-linearities in the process can be compensated by higher weighting of higher values. Can be used e.g. in fluid bed dryers or under silo flaps where non-linearities can occur due to changes in the material density during process. "Offset" works together with the parameter " Average-time ".
Weight Standard Setting: 5 values Setting Range: 050 Unit: Measurement Values	CA/CF/CK: inactive CH: Smoothing factor for analog output setting. This parameter influences the reaction/response time with factor 3. E.g. 15 values responds to a reaction time of 15/3=5 seconds. CK: The reaction/response time works nearly 1:1. E.g. 15 values responds to a reaction time of 15 seconds.

<p>Invalid Measure Count Standard Setting: 2 values Setting Range: 0..... 10 Unit: Measurement Values with 3 single values per second.</p>	<p>CA/CF/CK: inactive CC/CH: Number of discarded (poor) measurement values after the start of a new batch, when „No-Material-Delay“ has triggered. The first measurement values will be rejected, e.g. due to dripping water.</p>
<p>Moisture Std. Deviation Count Standard Setting: 5 values Setting Range: 0..... 20 Unit: Measurement Values with 3 single values per second.</p>	<p>CA/CC/CF/CH/CK: If the parameters Temperature or EC-TRIME (RbC) are not needed, the analogue output 2 can be setted tot he mode Moist/Moist Std. Deviation. In this mode the standard deviation of all single moisture values can be outputted. With this function the homogeneity of the single measurement values can be determined and it is possible to control a regulating process, e.g. pressure regulation.</p>
<p>Quick und Quick-Precision With Meas Time (no. values) Unit: without unit! See in chapter „Software tool SONO-CONFIG“ under point „Setting the precision of a single value measurement“.</p>	<p>CA/CC/CF/CH/CK/CS: Recommended is Quick Precision with Meas Time=2 where the TDR pulse is detected precisely. For still a little better accuracies, Meas Time can be increased, however the single measurement cycle is increased by 60 milliseconds per step (e.g. from 280ms to 340ms). Older SONO probe versions do not have this Quick Precision function!</p>

2.1.1. Average Time in the measurement mode CA and CF

SONO probes establishes every 200 milliseconds a new single measurement value which is incorporated into the continual averaging and issues the respective average value in this timing cycle at the analogue output. The averaging time therefore accords to the “memory” of the SONO probe. The longer this time is selected, the more inert is the reaction rate, if differently moist material passes the probe. A longer averaging time results in a more stable measurement value. This should in particular be taken into consideration, if the SONO probe is deployed in different applications in order to compensate measurement value variations due to differently moist materials.

At the point of time of delivery, the *Average Time* is set to 4 seconds. This value has proven itself to be useful for many types of applications. At applications which require a faster reaction rate, a smaller value can be set. Should the display be too “unstable”, it is recommended to select a higher value.

2.1.2. Filtering at material gaps in mode CA and CF

A SONO probe is able to identify, if temporarily no or less material is at the probe head and can filter out such inaccurate measurement values (**Filter-Lower-Limit**). Particular attention should be directed at those time periods in which the measurement area of the probe is only partially filled with material for a longer time, i.e. the material (sand) temporarily no longer completely covers the probe head. During these periods (**Lower-Limit-Keep-Time**), the probe would establish a value that is too low. The **Lower-Limit-Keep-Time** sets the maximum possible time where the probe could determine inaccurate (too low) measurement values.

Furthermore, the passing or wiping of the probe head with metal blades or wipers can lead to the establishment of too high measurement values (**Filter-Upper-Limit**). The **Upper-Limit-Keep-Time** sets the maximum possible time where the probe would determine inaccurate (too high) measurement values.

Using a complex algorithm, SONO probes are able to filter out such faulty individual measurement values. The standard settings in the **Measurement Mode CA and CF** for the filter functions depicted in the following have proven themselves to be useful for many applications and should only be altered for special applications.

It is appropriate to bridge material gaps in mode CA with Upper- and Lower-Limit Offsets and Keep-Time. For example the Lower-Limit Offset could be adjusted with 2% with a Lower-Limit Keep-Time of 5 seconds. If the SONO probe determines a moisture value which is 2% below the average moisture value with e.g. 8%, than the average moisture value will be frozen at this value during the Lower-Limit Keep-Time of 5 seconds. In this way the material gap can be bridged. This powerful function inside the

SONO probe work here with a highpass filter where the higher moisture values are used for building an average value, and the lower or zero values are filtered out. In the following this function is described with SONO parameters.

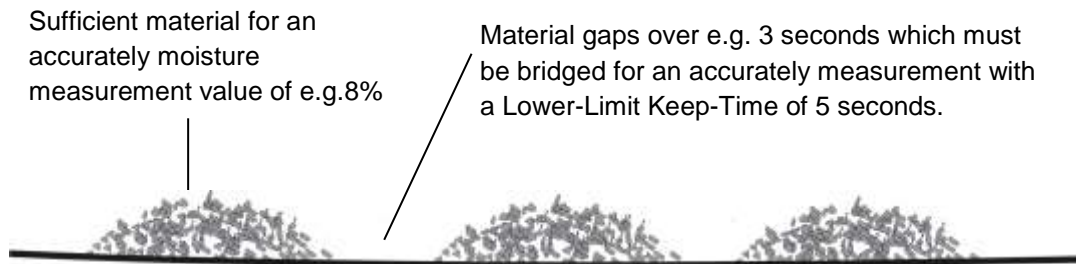

The following parameter setting in mode CA fits a high pass filtering for bridging material gaps.

Average Mode under Mode C	
CA-Cyclic Average	
Average Parameters:	
Average Time(s)	1
Filter Upper Limit Offset	20
Filter Lower Limit Offset	2
Upper Limit Keep Time	10
Lower Limit Keep Time	5

The Filter Upper-Limit is here deactivated with a value of 20, the Filter Lower-Limit is set to 2%. With a Lower-Limit Keep-Time of 5 seconds the average value will be frozen for 5 seconds if a single measurement value is below the limit of 2% of the average value. After 5 seconds the average value is deleted and a new average value building starts. The Keep-Time function stops if a single measurement value lies within the Limit values.

2.1.3. Mode CC – automatic summation of a moisture quantity during one batch process

Simple PLCs are often unable to record moisture measurement values during one longer batch process with averaging and data storage. Furthermore there are applications without a PLC, where accumulated moisture values of one batch process should be displayed to the operating staff for a longer time. Previously available microwave moisture probes on the market show two disadvantages:

1. Such microwave probes need a switching signal from a PLC for starting the averaging of the probe. This increases the cabling effort.
2. Material gaps during one batch process will lead to zero measurement values which falsify the accumulated measurement value considerably, recipe errors can occur.

Unlike current microwave probes, SONO probes work in mode CC with automatic summation, where it is really ensured that the measured material has contact with the probe. This increases the reliability for the moisture measurement during one complete batch process. The summation is only working if material fits at the probe. Due to precise moisture measurement also in the lower moisture range, SONO probes can record, accumulate and store moisture values during a complete batch process without an external switching or trigger signal. The SONO probe “freezes” the analogue signal as long as a new batch process starts. So the PLC has time enough to read in the “frozen” moisture value of the batch. For applications without a PLC the “frozen” signal of the SONO probe can be used for displaying the moisture value to a simple 7-segment unit as long as a new batch process will start.

With the parameter **Moisture Threshold**, the SONO probe can be configured to the start moisture level where the summation starts automatically. Due to an automatic recalibration of SONO probes, it is ensured that the zero point will be precisely controlled. The start level could be variably set dependent to the plant. Recommended is a level with e.g. 0.5% to 1%.

With the parameter **No-Material-Delay** a time range can be set, where the SONO probe is again ready to start a new batch process. Are there short material gaps during a batch process which are shorter than the "No-Material-Delay", with no material at the probes surface, then the SONO probe pauses shortly with the summation. Is the pause greater as the "No-Material-Delay" then the probe is ready to start a new batch process.

Please note: If the PLC already accumulates single moisture values in higher cycle rates, than an additional automatic summation of a moisture quantity inside the SONO-probe during one batch process will produce errors. Here mode CS is recommended.

How can the mode CC be used, if the SONO probe cannot detect the „moisture threshold“ by itself, e.g. above a conveyor belt if there is constant material covering above the probe head over a longer time: In this case, a short interrupt of the probe's power supply, e.g. for about 0.5 seconds with the help of a relay contact of the PLC, can restart the SONO probe at the beginning of the material transport. After this short interrupt the SONO probe starts immediately with the summarizing and averaging.

Please note: It should be noted that no material sticks on the probes surface. Otherwise the moisture zero point detection of the probe will be shifted up and the probe would not be detect a moisture low value below the "Moisture-Threshold".

Time chart for mode CC

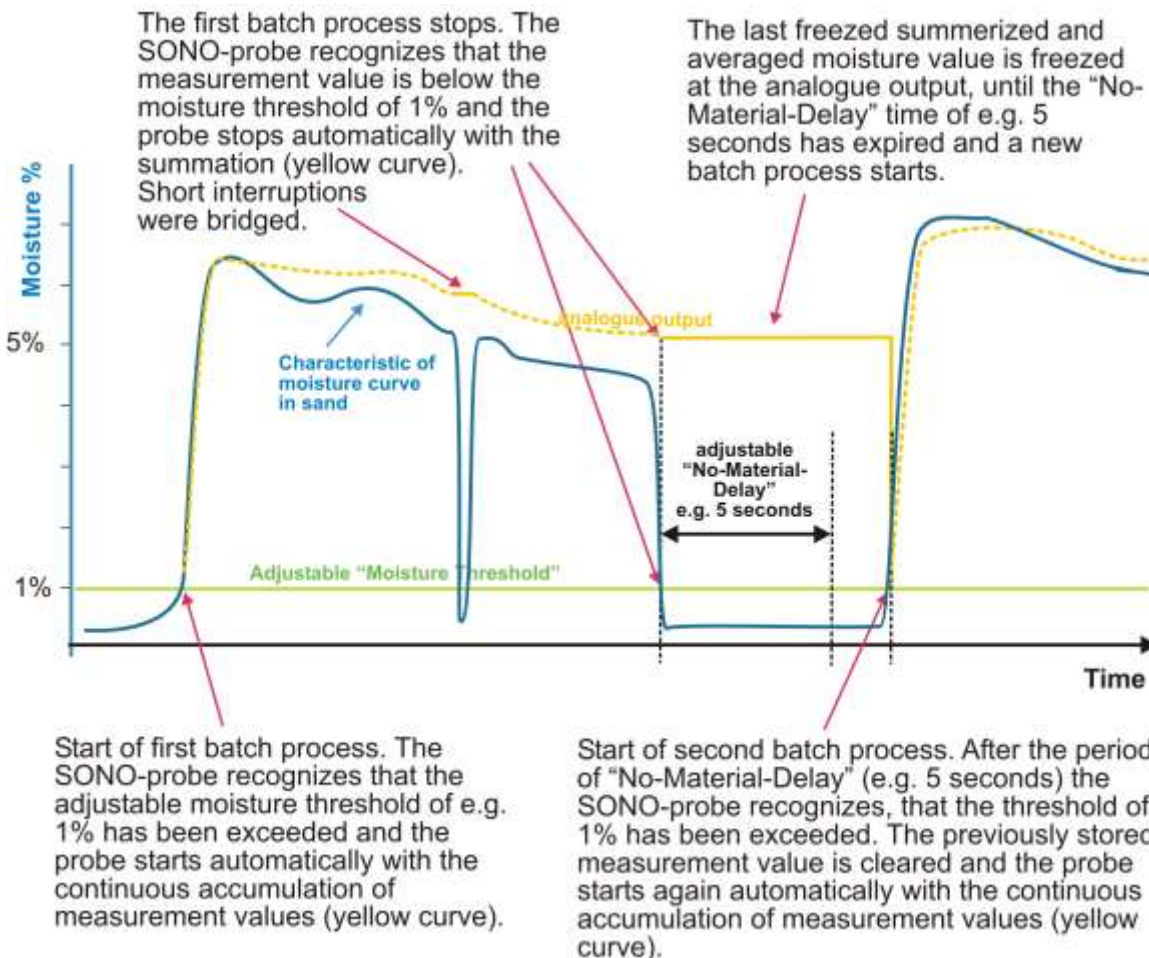

2.1.4. Mode CH – Automatic Moisture Measurement in one Batch

Mode CH can be used for applications in the construction industry. If the SONO-probe is installed under a silo flap, **Mode CH** can measure moisture when batch cycles are very short, down to 5 seconds (and perhaps shorter). Mode CH executes an automatic filtering with **Invalid Measure Count**, e.g. if dripping water occurs or for filtering out the first false measurements after opening the silo flap. The measurement cycle starts if the probe detects the **Moisture Threshold** value and freeze the analogue output value until the next cycle.

Mode CH (Cyclic Hold) is identically to Mode CC but without summation.

2.2. Overview of single modes for different applications

The following table gives an overview about possible parameter settings in different modes:

<i>Application/ Installation and specific Parameters</i>	Sand/ Gravel under a silo flap	Above a conveyor belt	Inside a mixer	Inside a fluid bed dryer	Gene- rally simple appli- cations	in a screw conveyor with filtering options due to metal spiral	At the end of a screw conveyor Long term process
Operating Mode	CH	CH	CH	CK	CH	CH	CF
Average- Time	2	2	2	5	2	2	30
Filter- Upper-Limit Offset	inactiv 100	inactiv 100	inactiv 100	inactiv 100	inactiv 100	inactiv 100	e.g. 20
Filter- Lower-Limit Offset	inactiv 100	inactiv 100	inactiv 100	inactiv 100	inactiv 100	inactiv 100	e.g. 5
Upper- Limit-Keep- Time	inactiv 10	inactiv 10	inactiv 10	inactiv 10	inactiv 10	inactiv 10	e.g. 10
Lower- Limit-Keep- Time	inactiv 10	inactiv 10	inactiv 10	inactiv 10	inactiv 10	inactiv 10	e.g. 10
Moisture Threshold	0.1	0.1	0.1	0.1	0.1	0.1	-
No-Material- Delay	10	10	10	10	10	10	-
Boost	35	35	35	20	35	35	-
Offset	0.5	0.5	0.5	1	0.5	0.5	-
Weight	5	5	5	25	5	5	-
Invalid Measure Count	2	2	2	inactiv	2	2	-

For very difficult applications, where it is not certain which mode is the best inside the SONO-probe, we recommend to select **mode CA** with averaging time = 1 second. With help of the software SONO-CONFIG a data record can be stored directly during process conditions. After forwarding this data set to IMKO, we would be pleased to be at your disposal for finding the best suitable working mode.

3. SONO Probes for measuring Moisture of Sand and Aggregates

The TRIME-TDR technology with the radar method offers high reliability for measuring moisture of sand and aggregates. Conventional measurement techniques such as microwave technology show considerable dependencies in different grading ranges.

The calibration curve Cal1 "Universal Sand/Gravel/Grit" of a SONO probe is suitable for measuring the moisture in sand with a grading size of 0-2mm, as well as in gravel and grit.

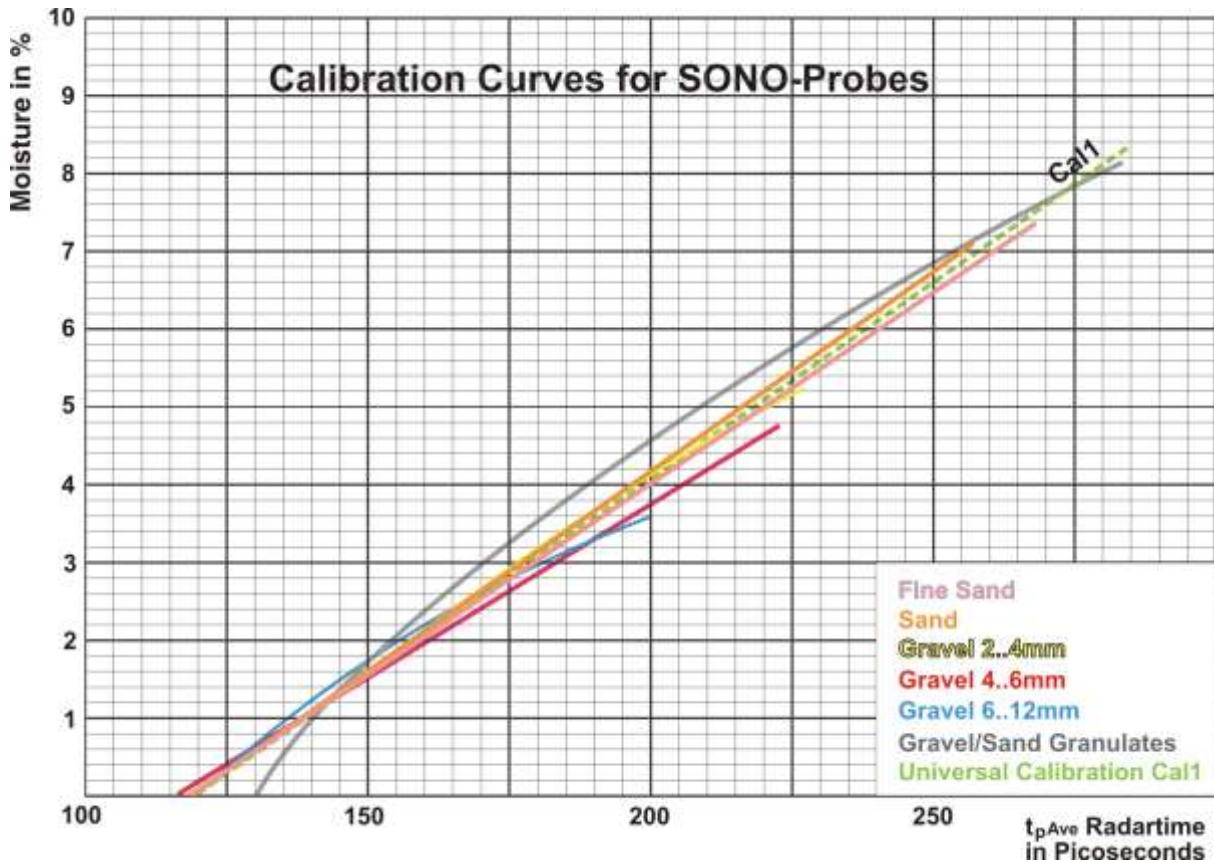

Fine Sand



Sand



Gravel 2..4mm



Gravel 4..6mm



Gravel 6..12mm



Gravel/Sand Granulates

3.1. SONO probes in use with different sand grading ranges

The sand density is varying depending on grading ranges but also on mineral type. The SONO probe as standard version is calibrated with calibration curve Cal1 for sand with a grading range of 0-2mm. With Cal1 it is also possible to measure gravel and grit. Depending on grading ranges the bulk density of sand is varying considerably. Therefore for other grading ranges up to 0-8mm there are other **calibration curves Cal1 to Cal6** stored inside the SONO probe.

Following table gives an overview about the calibration curves inside the SONO probe for sand, gravel and grit:

Aggregates and grading ranges	Bulk Density in kg/dm ³ Please note: the bulk density may also vary dependent on type of plant.	Recommended Calibration Curve
Sand 0-2mm,	D= c. 1,5	Cal1: Universal sand, gravel and grit
Gravel and grit 4 to 32mm	D= c. 1,7	Cal6: gravel and grit (similar to Cal1)
Sand 0-2mm	D= c. 1,6	Cal2, 1.6 for bulk density 1.6
Sand/Gravel 0-4mm	D= c. 1,7	Cal3, 1.7 for bulk density 1.7
Sand/Gravel 0-5mm	D= c. 1,8	Cal4, 1.8 for bulk density 1.8
Sand/Gravel 0-8mm	D= c. 1,9	Cal5, 1.9 for bulk density 1.9

For very high demands in recipe accuracies, e.g. +-1 liter per m³, it is recommended to make a fine adjustment of the moisture value with a target accuracy of e.g. +-0.05%, ideally inside the PLC.

How is it possible to avoid a change of the calibration curve inside the SONO-probe for different sand grading ranges?

If it is necessary to measure with only one SONO-probe several and very different sand grading ranges without an online changing of the calibration curve, than a measurement value conversion can be done inside the PLC with the known grading range. Furthermore it could be of advantage if a SONO probe must be not adapted/selected to a fixed grading range which makes replacement parts easier to keep in stock.

Following table gives an overview about sand grading ranges, bulk density and the analog output of the SONO probe. With a little math it is possible to translate a standard moisture measurement value measured with Cal1, into the correct measurement value associated to the grading range.

4-20mA Current output: Measurement conversion for 0 to 20% moisture at different sand grading ranges with standard calibration curve Cal1:

Grading range and bulk density in kg/dm ³	Moisture value at 4mA current at the analog output (theoretically)	A value of 0% moisture content thus conforms to an output current in mA at the analog output of:	Moisture value at 20mA output current at the analog output:
0-2mm 1.5	0.00%	4mA	20%
0-2mm 1.6	-0.29%	4.24mA	18.4%
0-4mm 1.7	-0.55%	4.48mA	17.1%
0-5mm 1.8	-0.78%	4.72mA	15.9%
0-8mm 1.9	-0.98%	4.96mA	14.8%
2.0	-1.16%	5.2mA	13.8%
2.1	-1.33%	5.44mA	12.9%

0-20mA Current output: Measurement conversion for 0 to 20% moisture at different sand grading ranges with standard calibration curve Cal1:

Grading range and bulk density in kg/dm ³	Moisture value at 4mA current at the analog output (theoretically)	A value of 0% moisture content thus conforms to an output current in mA at the analog output of:	Moisture value at 20mA output current at the analog output:
0-2mm 1.5	0.00%	0mA	20%
0-2mm 1.6	-0.29%	0.3mA	18.4%
0-4mm 1.7	-0.55%	0.6mA	17.1%
0-5mm 1.8	-0.78%	0.9mA	15.9%
0-8mm 1.9	-0.98%	1.2mA	14.8%
2.0	-1.16%	1.5mA	13.8%
2.1	-1.33%	1.8mA	12.9%

Please note: The guided values only apply for sand. For measuring gravel and grit with different gradings, it is recommended to use the standard calibration curve Cal1 or Cal6. Here, the analog output 0(4)-20mA corresponds to 0-20% moisture.

Caution: When calibrating the SONO-VARIO and comparative measurements with nominal values (kiln dried values), it must be taken into account that the core moisture of sand and gravel is not included in the recipe values. The core water in sand and gravel is not intended for cement hydration and should therefore be "calibrated out". This should be considered, in particular, for very absorbent aggregates:

Moisture value SONO-VARIO = kiln dried moisture - core moisture

4. Calibration Curves

SONO probes can measure moisture in very different materials.

For applications in construction industry, SONO probes are supplied with a universal calibration curve for sand (Cal1: Universal Sand/Gravel/Grit). A maximum of 15 different calibration curves (CAL1 ... Cal15) are stored inside the SONO probe and can optionally be activated with help of the program **SONO-CONFIG** via the serial interface with the modules **SONO-VIEW** or **SM-USB**.

A preliminary test of an appropriate calibration curve (Cal1. .15) can be activated in the menu "**Calibration**" and in the window "**Material Property Calibration**" by selecting the desired calibration curve (Cal1...Cal15) and with using the button "**Set Active Calib**". The finally desired and possibly altered calibration curve (Cal1. .15) which is activated after switching on the probes power supply will be adjusted with the button "**Set Default Calib**".

Nonlinear calibrations are possible with polynomials up to 5th grade (coefficients m0...m5).

IMKO offers more suitable calibration coefficients for different materials. These calibration coefficients can be entered and stored in the SONO probe by hand with the help of SONO-CONFIG.

The charts (Cal.1 .. 15) in the next two pages show different selectable calibration curves which are stored inside the SONO probe.

Plotted is on the y-axis the gravimetric moisture (**MoistAve**) and on the x-axis depending on the calibration curve the associated radar time **tpAve** in picoseconds. With the software **SONO-CONFIG** the radar time **tpAve** is shown on the screen parallel to the moisture value **MoistAve** (see "Quick Guide for the Software SONO-CONFIG). In air, SONO-probes measure typically 60 picoseconds radar time, in water 1000 picoseconds.

4.1. A calibration curve for "sand drying"

To come to best possible accuracies for the application **sand drying**, IMKO recommends the use of the moisture probe **SONO-VARIO Xtrem**, because this probe works with a special ceramic (dark color) with best-possible characteristics to measure moisture very precise also at very high temperatures.

To ensure, that sand moisture can be measured exactly down to 0.0%, the SONO-VARIO Xtrem must be adjusted to an accurate zero point. Imko recommends to use the **Universal Sand Cal1** calibration curve for this application.

The accurate zero point depends on several factors:

- From the type of sand like: silica sand, broken sand, calcareous sandstone, etc.
- from the flow of the sand above the probe's surface,
- from the installation point of the SONO-VARIO Xtrem,
- perhaps from other parameters.

Directly during process, the **display module SONO-VIEW** can be used to adjust exactly the zero point with the function **Offset Balancing**. It must be secured, that a sufficient quantity of sand is used for comparing the probe's moisture values with kiln drying moisture values. If it appears that e.g. the SONO-VARIO Xtrem has measured moisture values with 0.3% positive deviation (too high), than it is possible directly during process, to correct the calibration curve downwards with -0.3% with help of **SONO-VIEW** and the function **Offset Balancing**.

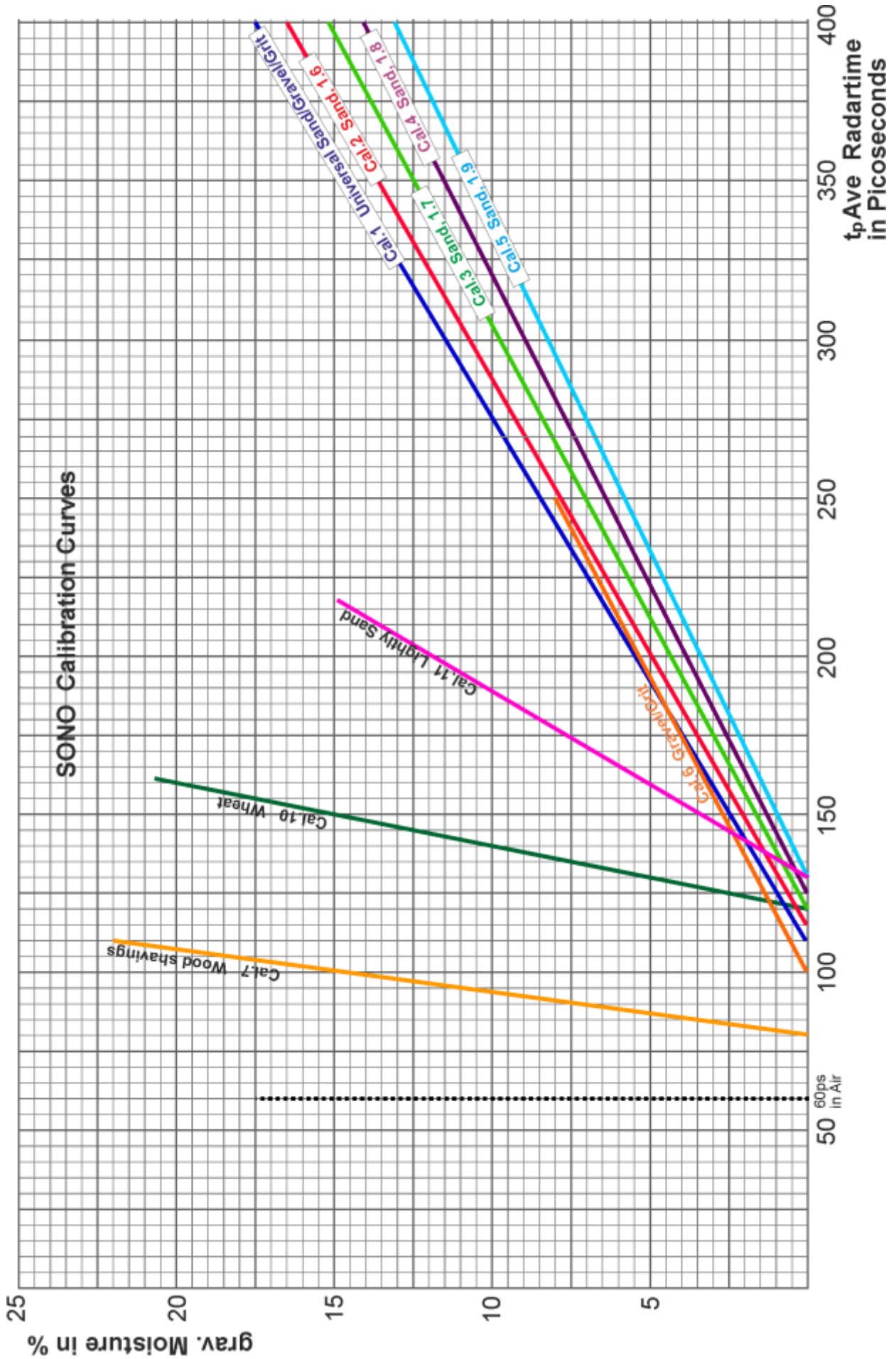

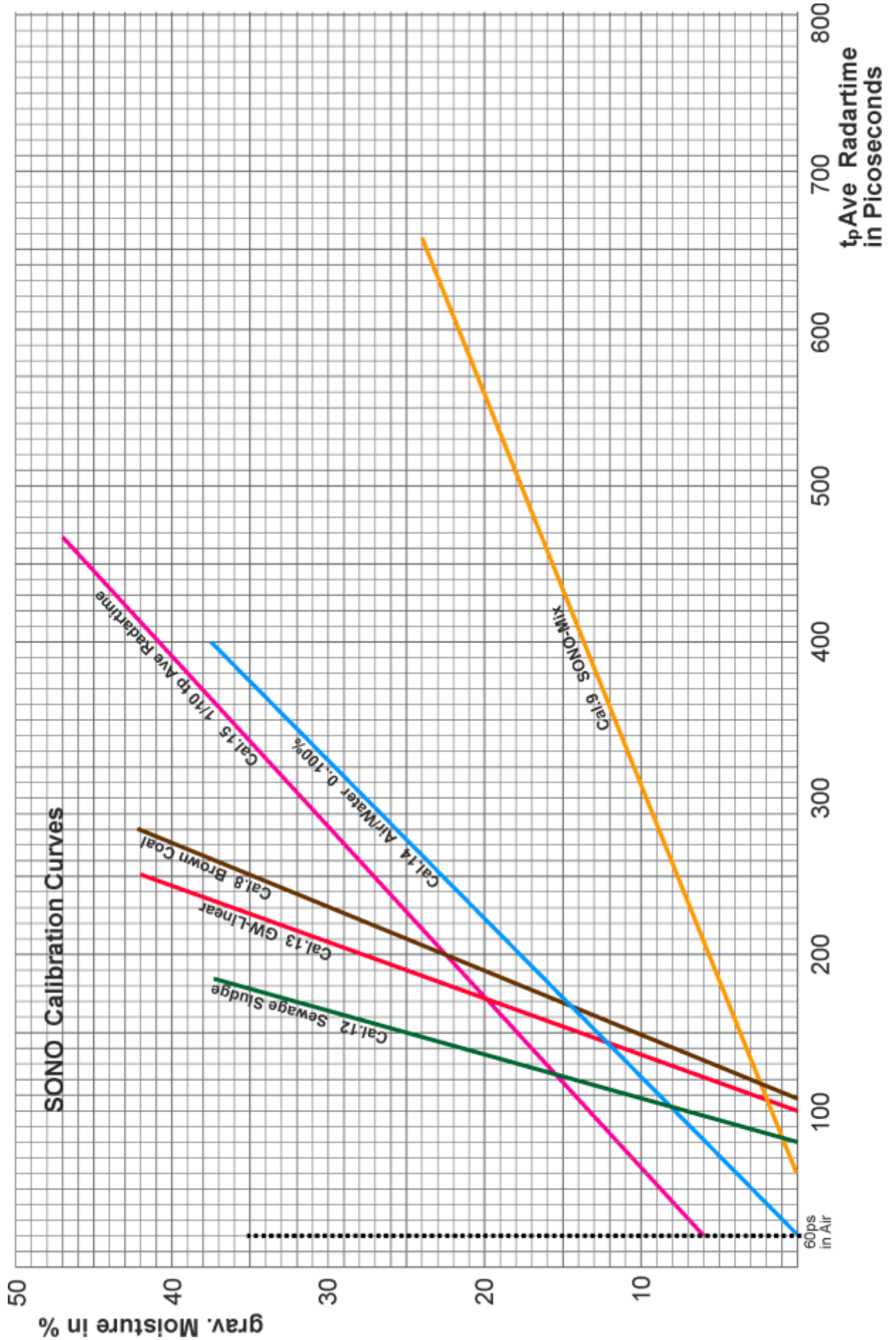

4.2. Creating a linear Calibration Curve for a specific Material

The calibration curves Cal1 to Cal15 can be easily created or adapted for specific materials with help of SONO-CONFIG. Therefore, two measurement points need to be identified with the probe. **Point P1 at dried material** and **point P2 at moist material** where the points P1 and P2 should be far enough apart to get a best possible calibration curve. The moisture content of the material at point P1 and P2 can be determined with laboratory measurement methods (oven drying). It is to consider that sufficient material is measured to get a representative value.

Under the menu "**Calibration**" and the window "**Material Property Calibration**" the calibration curves CAL1 to Cal15 which are stored in the SONO probe are loaded and displayed on the screen (takes max. 1 minute). With the mouse pointer individual calibration curves can be tested with the SONO-probe by activating the button "**Set Active Calib**". The measurement of the moisture value (**MoistAve**) with the associated radar time **tpAve** at point P1 and P2 is started using the program SONO-CONFIG in the sub menu "**Test**" and "**Test in Mode CF**" (see "Quick Guide for the Software SONO- CONFIG").

Step 1: The radar pulse time **tpAve** of the probe is measured with dried material. Ideally, this takes place during operation of a mixer/dryer in order to take into account possible density fluctuations of the material. It is recommended to detect multiple measurement values for finding a best average value for **tpAve**. The result is the first calibration point P1 (e.g. 70/0). I.e. 70ps (picoseconds) of the radar pulse time **tpAve** corresponds to 0% moisture content of the material. But it would be also possible to use a higher point P1' (e.g. 190/7) where a **tpAve** of 190ps corresponds to a moisture content of 7%. The gravimetric moisture content of the material, e.g. 7% has to be determined with laboratory measurement methods (oven drying).

Step 2: The radar pulse time **tpAve** of the probe is measured with moist material. Ideally, this also takes place during operation of a mixer/dryer. Again, it is recommended to detect multiple measurement values of **tpAve** for finding a best average value. The result is the second calibration point P2 with X2/Y2 (e.g. 500/25). I.e. **tpAve** of 500ps corresponds to 25% moisture content. The gravimetric moisture content of the material, e.g. 25% has to be determined with laboratory measurement methods (oven drying).

Step 3: With the two calibration points P1 and P2, the calibration coefficients m_0 and m_1 can be determined for the specific material (see next page).

Step 4: The coefficients $m_1 = 0.0581$ and $m_0 = -4.05$ (see next page) for the calibration curve Cal14 can be entered directly by hand and are stored in the probe by pressing the button "**Set**". The name of the calibration curve can also be entered by hand. The selected calibration curve (e.g. Cal14) which is activated after switching on the probes power supply will be adjusted with the button "**Set Default Calib**".



Attention: Use "dot" as separator (0.0581) in SONO-CONFIG, not comma !

4.2.1. Calculation for a linear 2-point calibration curve

1. Download the Excel-Sheet „**SONO 2-Point LinearCalibration_Calculation**“ from IMKO's Homepage under „Support Software“.
2. Enter into the Excel-Sheet both TP-values with the respective reference moisture values.
3. Read out both parameters m_0 and m_1 from the Excel-Sheet.
4. Enter, set and save both parameters m_0 and m_1 with help of the software „SONO-CONFIG“ in the menu „**Calibration**“ in the window „**Material Property Calibration**“ in the selected calibration curve.

4.2.2. Calculation for a linear 1-point calibration curve

In practice during commissioning of a SONO probe in process, it could be happen that the measured material above the probe is only available with a single moisture value. So a 2-point calibration could not be carried out.

The procedure described below is not as precisely like a 2-point calibration, but it could be a compromise to achieve an acceptable result for a usable calibration curve.

Below you will find the basic steps which are necessary:

1. Measure the radar travel time **T_p** in the running process while the material lies or flows above the SONO probe's surface. **T_p** can be measured with help of the module **SM-USB** or with the display module **SONO-VIEW**.
2. Determine the reference moisture **M in %** of the measured material which lies above the SONO probe. Unless the material moisture is already known, the reference moisture can be determined with an infrared- or microwave oven in the laboratory.
3. Determine the bulk **density D** of the material in kg per dm³. Unless the bulk density is already known this can be done by weighing of exactly 1 liter volume of the material.
4. Download the Excel-Sheet „**SONO 1-Point LinearCalibration_Calculation**“ from IMKO's Homepage under „Support Software“. Enter the three determined parameters **T_p** (Radar travel time), **M** (Moisture) und **D** (bulk density) into the Excel-Sheet. As result you get the two calibration curve coefficients m0 and m1.
5. Enter, set and save both parameters m0 and m1 with help of the software „SONO-CONFIG“ in the menu „**Calibration**“ in the window „**Material Property Calibration**“ in the selected calibration curve. The three parameters **T_p**, **M** and **D** can be also entered without a PC with the module SONO-VIEW (see manual SONO-VIEW).

4.2.3. Calculation for a non-linear calibration curve

SONO probes can work also with non-linear calibration curves with polynomials up to 5th grade. For a non-linear calibration it is necessary to calibrate with 4...8 different calibration points with different T_p values and the related moisture values in %. To calculate nonlinear coefficients for polynomials up to 5th grade, an EXCEL software tool from IMKO can be used.

1. Download the Excel-Sheet „**SONO_NonlinearCalibration_Calculation**“ from IMKO's Homepage under „Support Software“.
2. Enter the T_p-values with the respective reference moisture values into the Excel-Sheet.
3. Read out the parameters m0 to m5 from the Excel-Sheet.
4. Enter, set and save the parameters m0 to m5 in the selected calibration curve with help of the software „SONO-CONFIG“ in the menu „**Calibration**“ under the window „**Material Property Calibration**“.

5. Connectivity to SONO Probes

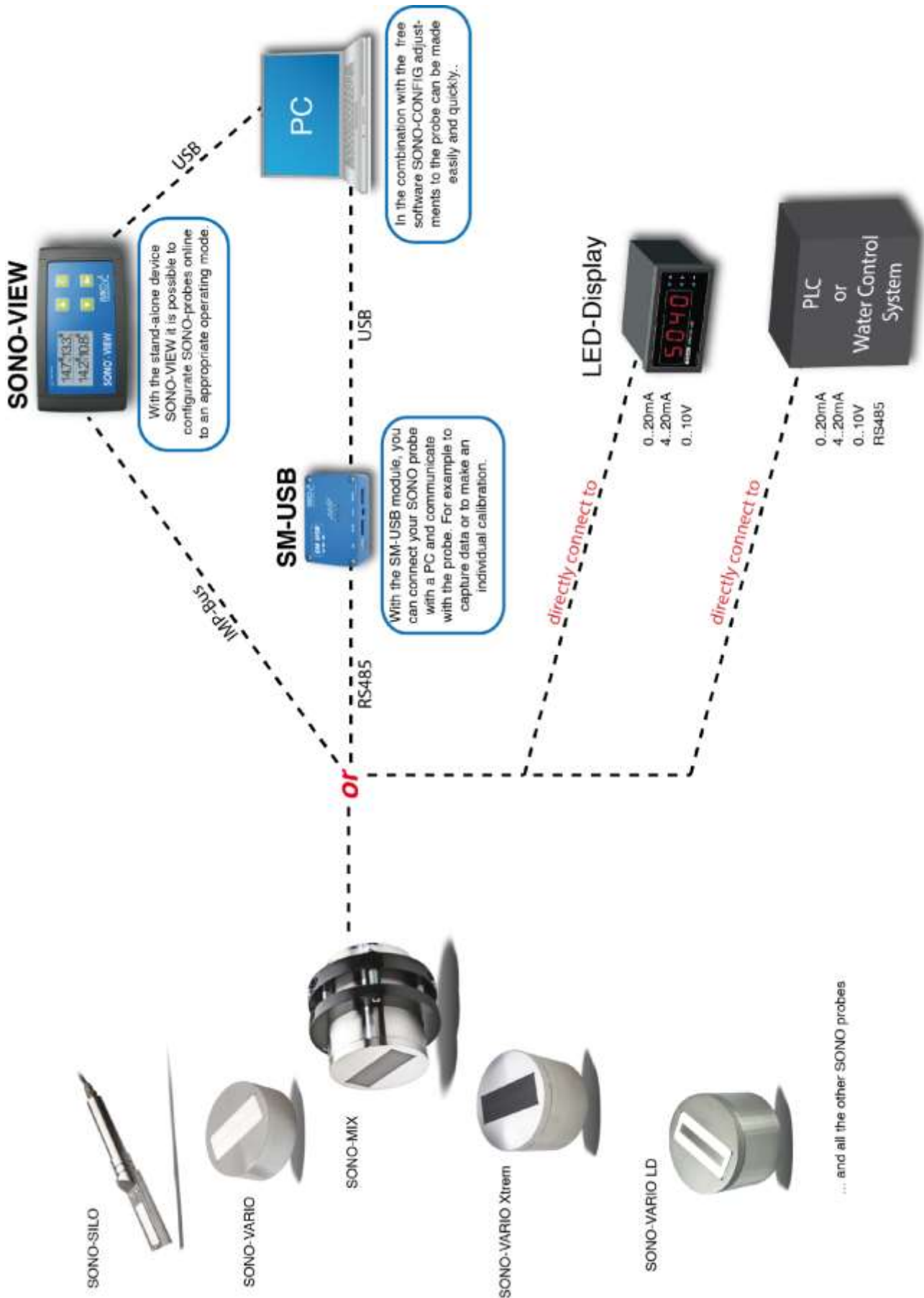

5.1. Connection Plug and Plug Pinning

SONO-VARIO is supplied with a 10-pole MIL flange plug.

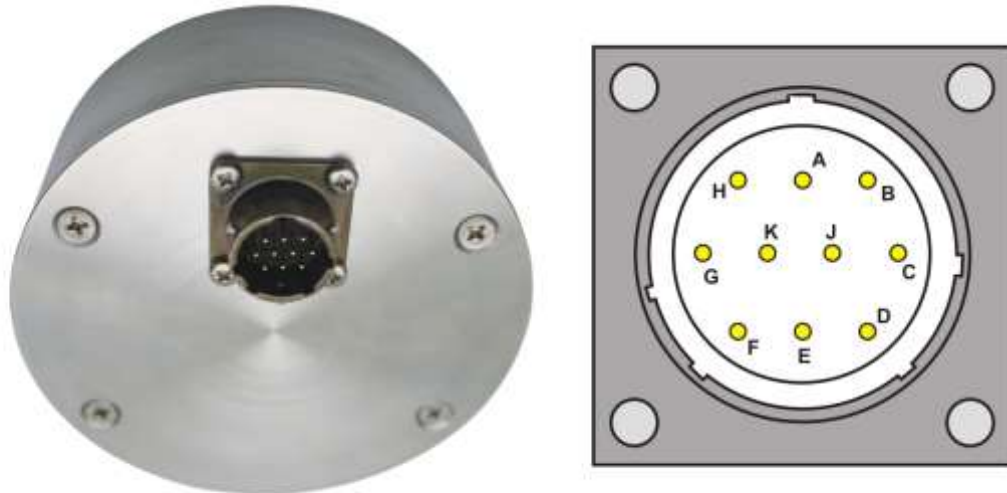

Assignment of the 10-pole MIL Plug and sensor cable connections:

Plug-PIN	Sensor Connections	Lead Colour	Lead Colour
A	+12V....24V Power Supply	red	red
B	0V Power Supply	Blue	Blue
D	1. Analogue Positive (+) Moisture	Green	Green
E	1. Analogue Return Line (-) Moisture	yellow	yellow
F	RS485 A (has to be activated)	white	white
G	RS485 B (has to be activated)	brown	brown
C	(rt) IMP-Bus	grey/pink	grey/pink
J	(com) IMP-Bus	blue/red	blue/red
K	2. Analogue Positive (+)	Pink	Pink
E	2. Analogue Return Line (-)	Grey	Grey
H	Screen (is grounded at the sensor. The plant must be properly grounded!)	transparent	transparent

5.2. Analogue Output 0..10V with a Shunt-Resistor

There are PLC's which have no current inputs 0..20mA, but voltage inputs 0..10V. With the help of a shunt resistor with 500 ohm (in the delivery included) it is possible to generate a 0..10V signal from the current signal 0..20mA. The 500 ohm shunt resistor should be placed at the end of the line resp. at the input of the PLC. Following drawing shows the circuit principle.

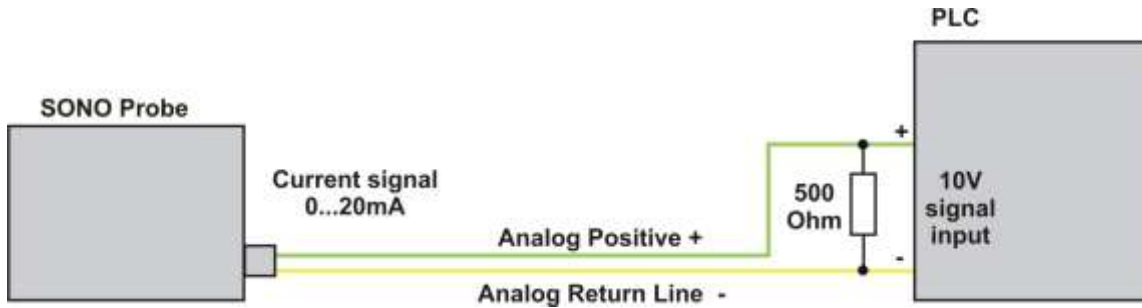

5.3. Connection Diagram with the Display Module SONO-VIEW

The stand-alone module SONO-VIEW permits the display of moisture values and configuration for advanced process control with SONO probes.



SONO-VARIO



SONO-SILO

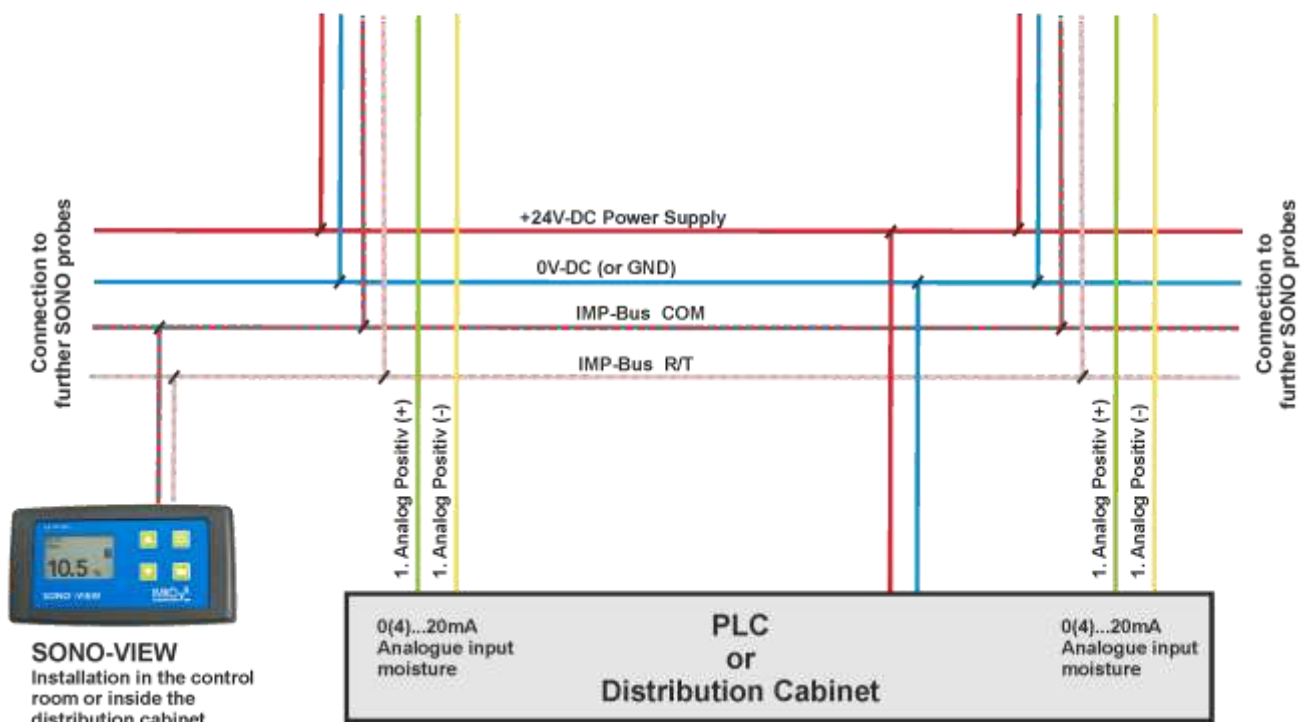

6. Installation of the Probe

The installation conditions are strongly influenced by the constructional circumstances of the installation facility. The ideal installation location must be established individually. For measuring sand, gravel and grit, the SONO-VARIO should ideally be installed under a silo valve, which has many advantages (see below).

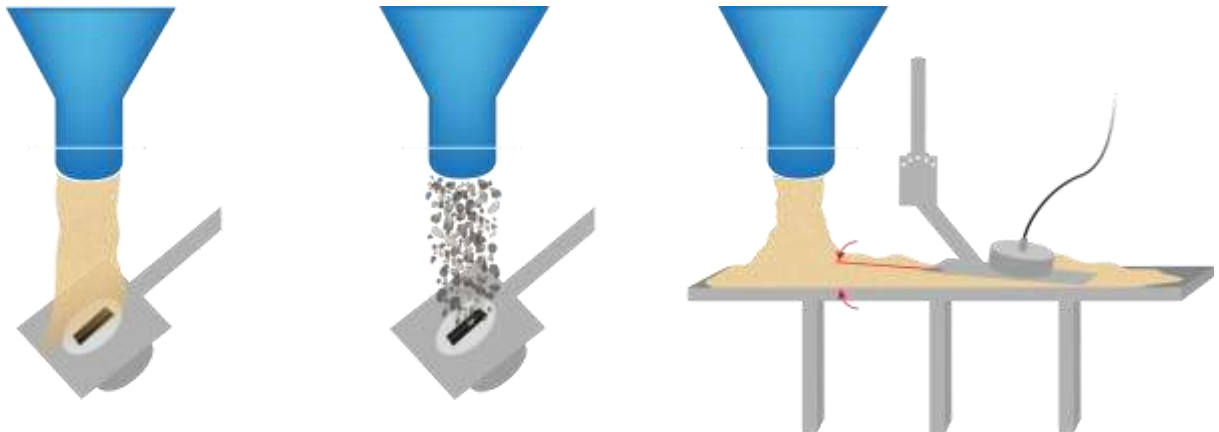

*Installation of the SONO-VARIO for measuring sand, gravel and grit, under a silo valve or on a conveyor belt. Dependent on material, it is important **to find the suitable angle of the mounting plate**. It should be not too steep, but also not too flat and **the flowing material should cover the probes surface completely** during flowing. But material should also not accumulate.*

It should be mentioned, that with the innovative features of SONO-probes and an extremely rugged design, it is possible, to install a SONO-VARIO directly under valves of silos, also for gravel with 32mm size. The installation inside a silo could be also possible, but it must be observed, that during filling and emptying, no material (e.g. sand) can be stick on the probes surface, which could be result in measurement errors. The following instructions should be followed when installing the probe:

The SONO-VARIO should be installed ideally under a valve of the silo, which has many advantages:

1. The material flows constant and therefore the material density is constant which guarantees more precise measurement values.
2. Due to higher material pressure, the probe's surface is cleaned continuously. Material sticking and therefore measurement errors are prevented.
3. The SONO-VARIO can detect clearly the start and the end of a batch process. So the SONO-VARIO can calculate an automatic summation of the moisture quantity during one batch process in mode CC. Even short batches with few material can be precisely measured. Further advantage is that the PLC programming can be made more simple without switching signals.



Unfavourable conditions for moisture probes occur if the probes are installed inside silos or inside outlets

The picture shows how sticky and adhere sand can be, even at near-vertical walls. Furthermore a moisture probe can be seen which is installed directly inside the outlet of a silo, where sand can stick not only at the wall but also on the moisture probe. Such an installation place can lead to measurement failures because it cannot be controlled visually.

6.1. Further important Assembly Instructions

The following instructions should be followed when installing the probe:

- The universal holder (baffle plate) should be installed direct under a silo flap, so that the flowing material covers the moisture probe completely with minimum 30mm material height. The direction of the material flow should be bundled against the sensors surface when the flap opens. This secures that the sensors surface is covered with material immediately after opening of the flap and not only when the flap has opened completely. It improves the measurement when measuring moisture at short batches with short opening speeds of the flap.
- For sand the angle of attack for the sensor holder should be between 45°-55°. For gravel and grit the angle must be more steep, between 55°-70° so that no backwater occurs above the probe's surface.

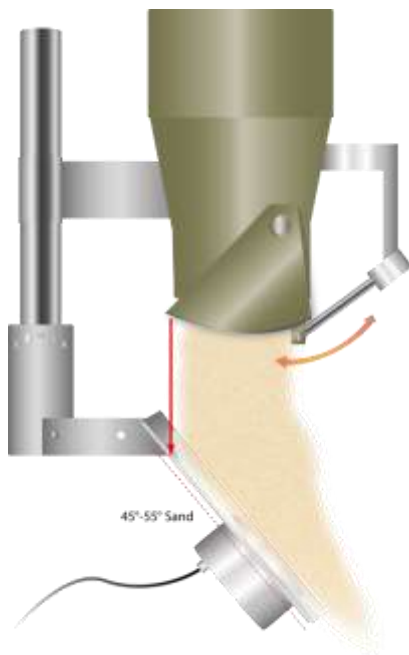

Sand: Angle baffle plate 45° to 55°

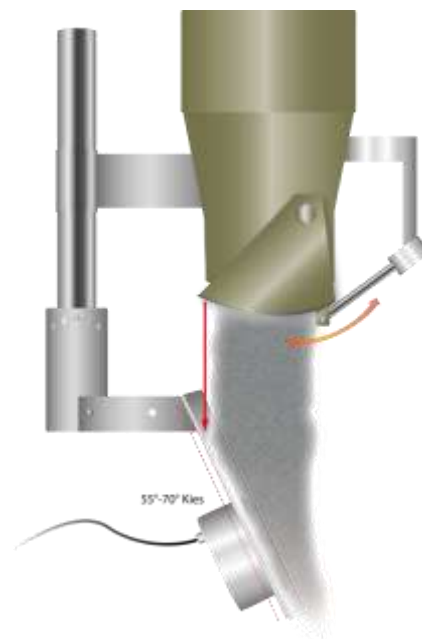

Gravel: Angle baffle plate 55° to 70°

Marked with red arrow: the silo flap should be lie just below the top edge of the baffle plate of the sensor. This ensures that the probe's surface is completely covered during material flow.

- **Important for measuring moisture of gravel and grit:**



Gravel or grit could have so much water, that free water can flow above the probes's surface. E.g. the maximum moisture content of gravel with 2-8mm grain size lies at 3.5%. For gravel with 8-32mm grain size the maximum lies at 2.5%.

The SONO probe can measure the water content in the range of 0 to 3.5% precise. But if gravel is completed saturated and free water flows above the SONO probe's surface, the probe's measurement could fail with values up to 7% moisture. Therefore for gravel it is necessary that a PLC calculates with a limit of e.g. 3.5% (or 2.5%). The PLC has to reduce a

higher moisture value of the probe to a maximum of 3.5% (or 2.5%) for gravel.

- The installation locations may not be situated beneath the inlets for additives.

- In case of an uneven base, the probe must be installed at the highest point of the base. No water may accumulate at the probe head as this could falsify the measurement.
- With the universal holder, deliverable by IMKO, the SONO-VARIO can be placed above a conveyor belt. Particularly with inhomogeneous or loose sand, the material can be constantly condensed, which leads to higher measurement results.
- Areas with strong turbulences are not ideal for the installation. There should be a continuous material flow above the probe head.
- For special installations inside mixing containers it should be noted that the stirring movement of blades should be conducted without gaps above the probe head.
- The probe should not be installed in the direct vicinity of electrical disturbing sources such as motors.
- In case of curved installation surfaces in containers, the centre of the probe head should be flush with the radius of the container wall without disturbing the radial material flow in the container. The probe may not project and come in contact with blades or wipers.
- **The probe connector should be protected against splashing water after installation.**

Attention! Risk of Breakage!

The probe head is made of hardened special steel and a very wear-resistant ceramic in order to warrant for a long life-span of the probe. In spite of the robust and wear-resistant construction, the ceramic plate may not be exposed to any blows as ceramic is prone to breakage.

Attention! Risk of Overvoltage!

In case of welding work at the plant, all probes must be completely electrically disconnected.

SONO-probes need a stabilized power supply with 12V-DC to max. 24 V-DC. With unstabilized power supply there is the risk of overvoltage. We strongly suggest not to use unstabilized power supplies.

Attention! Risk of Malfunction!

1. In larger concrete plants it could be possible, that there are different mass potentials for different power lines in use, especially if the PLC is installed in larger distances to the moisture probe. Here it could come to problems that the analogue moisture signal 0(4)..20mA could not be measured correctly in the PLC. With such a problem we recommend to use an isolated powerbox for the SONO probe. Available upon request by IMKO.
2. Take care that there are no other electromagnetic fields nearby the SONO probe. E.g. another moisture probe installed beside or in opposite of the SONO probe could influence the measurement field.

Any damage caused by faulty installation is not covered by the warranty!

Abrasive wear of sensor parts is not covered by the warranty!

6.2. Use of the highly wear-resistant slider

The highly wear resistant slider is suitable for moisture measurements of abrasive sand on the conveyor belt. The surface of the slider is made of tungsten carbide.



IMKO delivers three matching threaded rods for the slider. The following sketch shows a possible installation of the slider. The mechanical holder of the slider depends on the conveyor belt and has to be manufactured by the user.

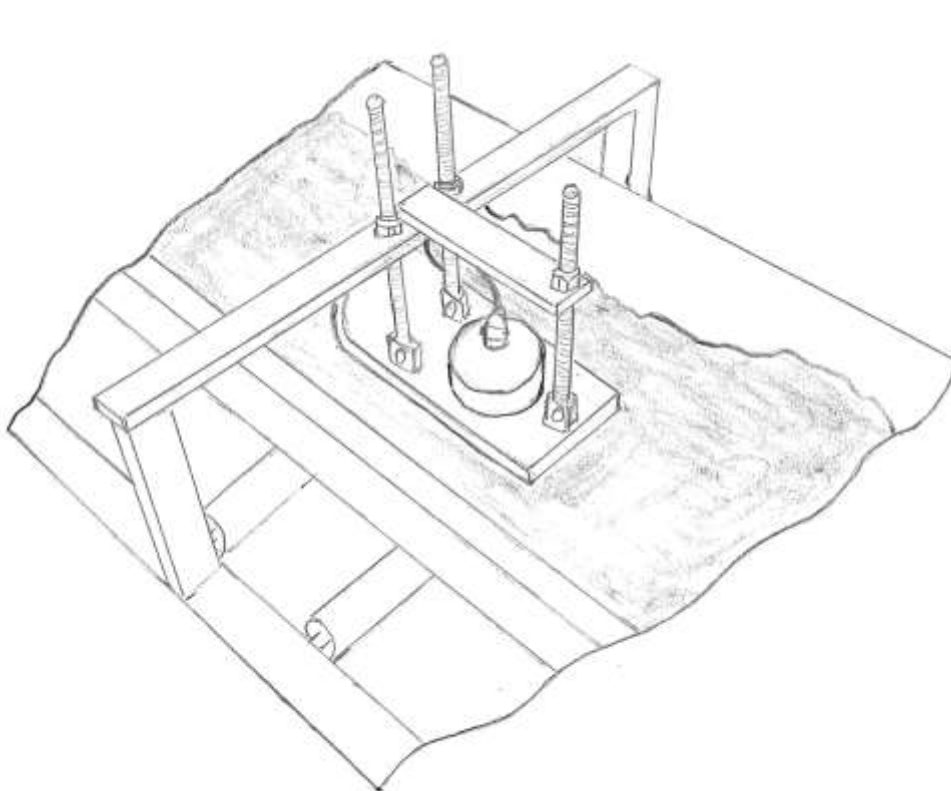

6.3. Protection of the probe's connector against splashing water

If sand and gravel flows above the baffle plate and could touch the probe connector of the SONO-probe, than it is recommended to mount an extra protection for the probe's connector. This is feasible e.g. with a commercial flexible garden hose with an inner diameter of 27mm. The hose can be slotted longitudinally and can be mounted around the connector and the cable. It could be fixed with cable ties. The following picture shows this solution for protection of the probe's connector.



Alternatively, the included shrink sleeve over the cable can be used. After installation of the SONO-probe and connection of the MIL-connector, the shrink sleeve can be shrunk with a hot air blower.



6.4. Assembly Dimensions

SONO-VARIO can either be installed at the base or the side wall of containers. One fact to consider is that the installation into the container base also enables the measurement of smaller material quantities. A mounting flange is available for SONO-VARIO. The flange can both be welded on to the base and the side wall of the container. The probe can be adjusted to the correct position, respectively correct installation height.

SONO-VARIOStandard:

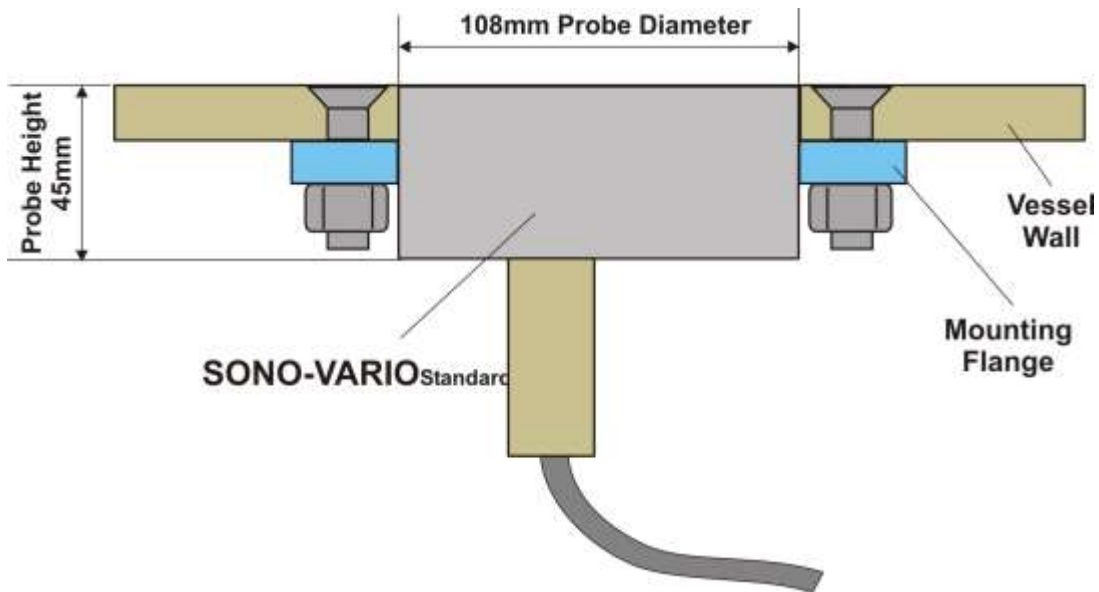

SONO-VARIOXtrem

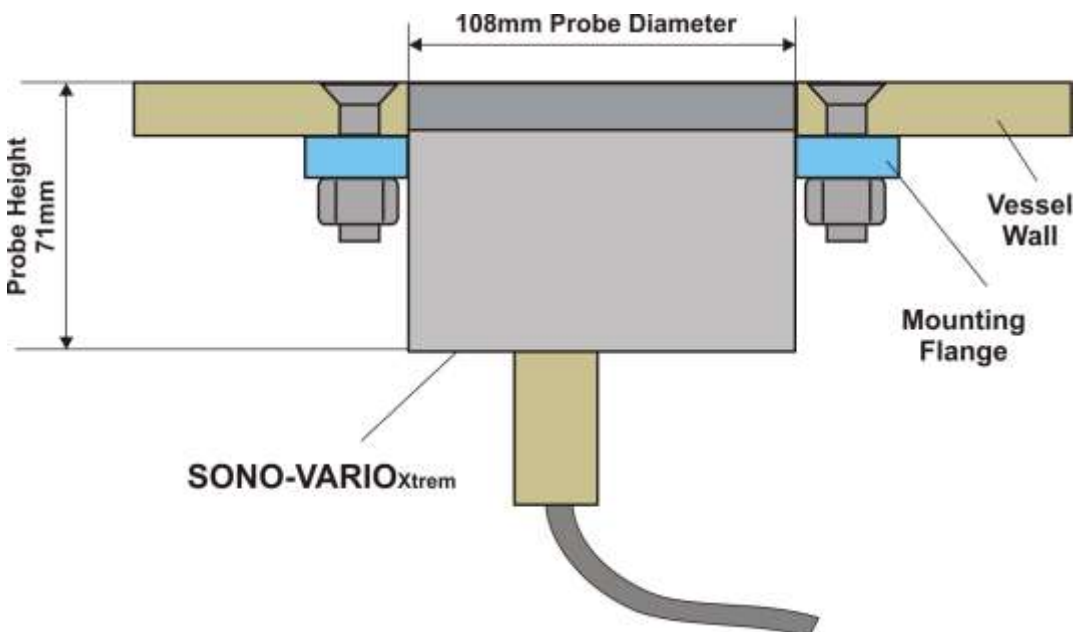

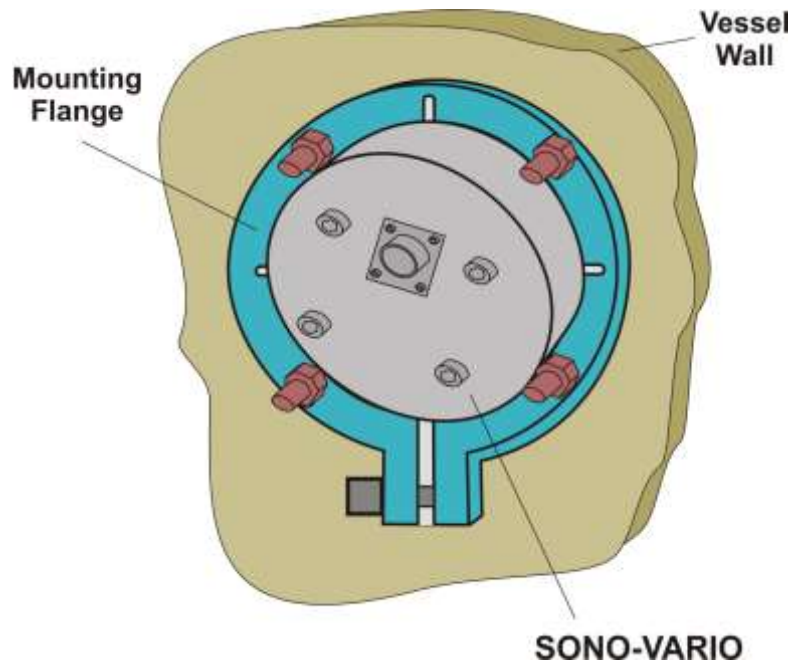

Dimensions of the Mounting Flange

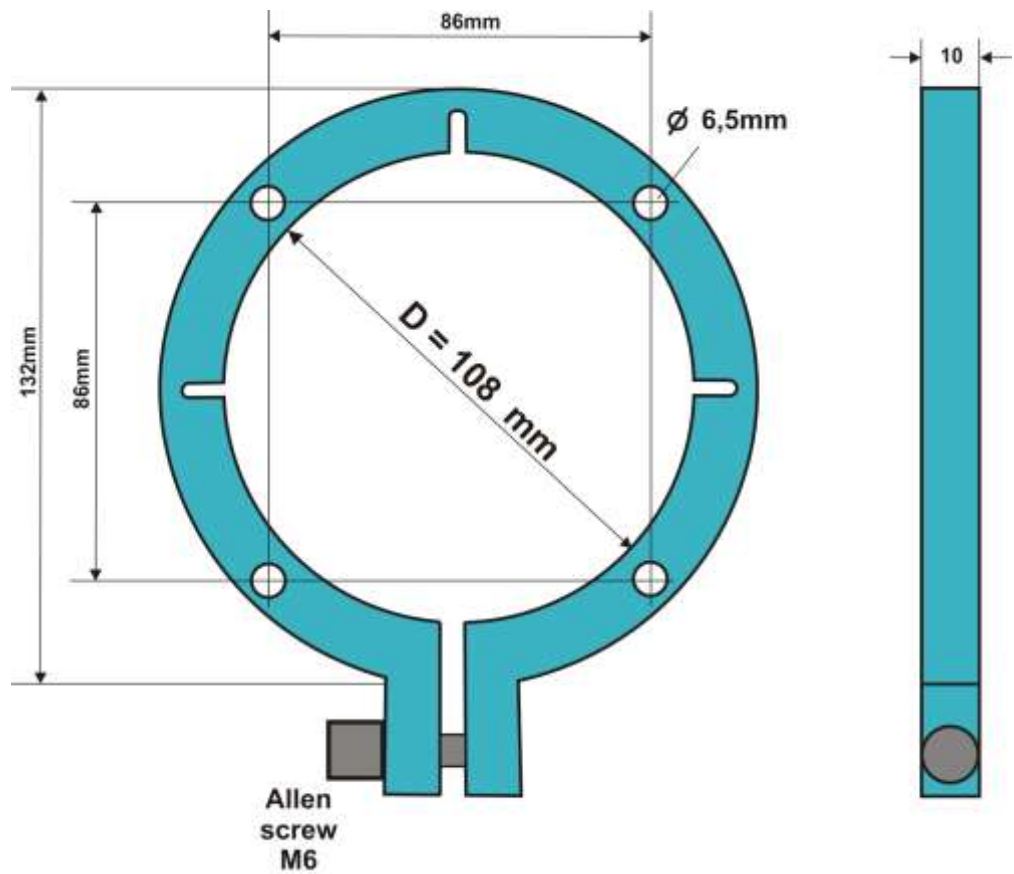

6.5. What to do if the Material Flow is not optimal?

But even the best sensor technology can deliver good results if special limits are respected concerning installation place, environmental conditions and the associated bulk density of the measured material.

Moisture probes need enough material above the probe's surface. SONO-probes have no problems above a coverage of 3cm and with higher coverage the field penetrates also deeper into the material. Remarks: **Microwave probes** show considerable dependency on bulk height and from the location of the field which is concentrated and can be disturbed in the center of the probe. The field has to pass twice a thick ceramic plate.

But there are plants where the material flow is so bright, that the material height is too less above the probes surface. Following picture shows a funnel chute where guiding plates left and right and also above the probe are bundling the material flow. Especially with sticky sand or other sticky materials it is recommended that the guiding plates are coated with PTFE or another plastic.

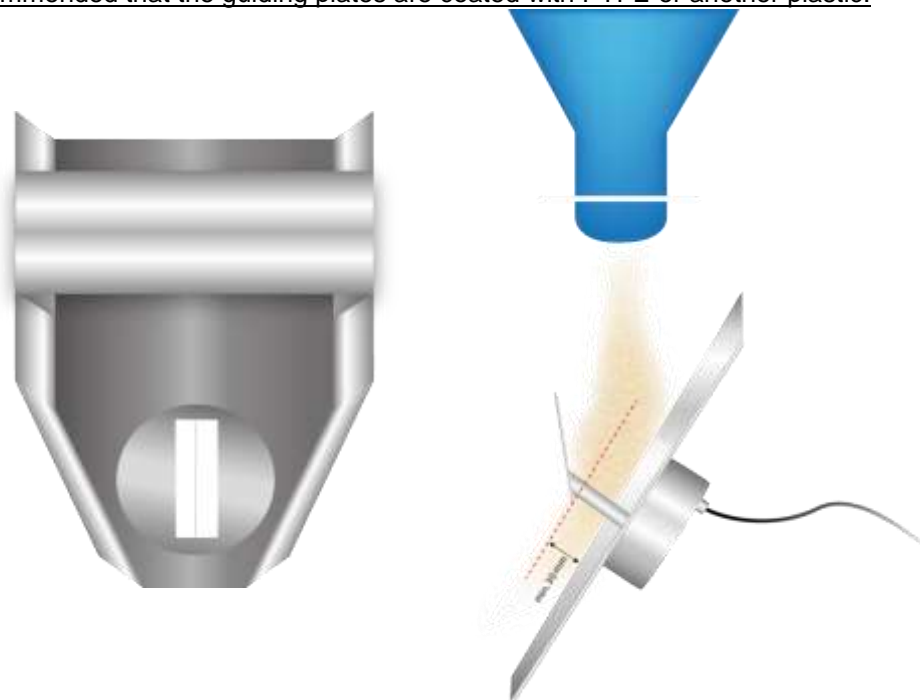

Please consider: The minimum material height above the probes surface is 30mm.

For discarding poor measurement values, it is also possible to implement filter functions in the SONO probe with Upper- and Lower Limit (please take a look under chapter „Operation Mode...“).

6.5.1. Installation of SONO-VARIO in a vibration chute



The direct installation of the SONO-VARIO in a vibrating channel is possible. The installation should take place at a point where the material overlay over the probe surface with min. 3cm is guaranteed.

6.6. Mounting in curved Surfaces

In order to prevent the probe head from projecting and interfering with wipers, the centre of the probe head should be flush with the radius of the wall. The ceramic must be laterally aligned to the rotational axis as the gap towards the wipers is smallest in this position.

In order to ensure that the probe head is completely covered with material, the probe is best positioned near the base. In order to prevent water from accumulating above the sensor head, which could falsify the measurement, an installation angle of approximately 30° above the base centre is recommended.

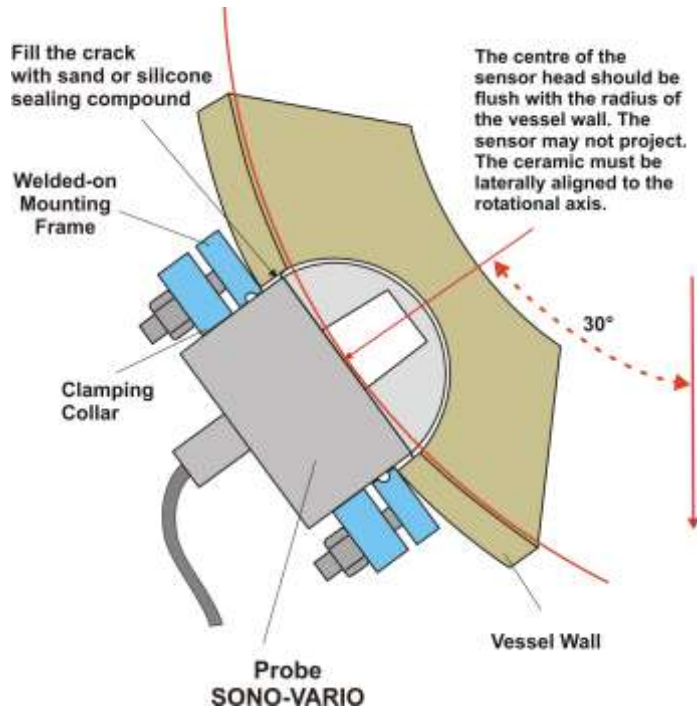

6.7. Gas- and waterproofed Installation in a Tube or Container

For a pressure-tight installation of a SONO probe in a vessel or a tube, a flange installation is recommended. For such applications we recommend to use IMKO's moisture probe **SONO-FLANGE**.

Information upon request.

6.8. What should be done if the moisture values of the SONO-VARIO does not fit?

It should be noted in advance that the SONO-VARIO is already pre-calibrated with the Cal1 calibration curve for standard sand (grading line 0-2mm) and gravel.

For the first commissioning, the measured moisture value of the SONO-VARIO should be at least + -1% accuracy.

If this is the case, then the SONO-VARIO can be fine-tuned to + -0.1% accuracy to the moisture value in different ways:

1. Depending on the PLC, it is possible to perform a parallel offset/shift in the PLC. Depending on the PLC, the parameter has different names, such as: preload, zero point, offset, measuring range, etc. **Please contact your control manufacturer.**
2. The SONO-VIEW module can be used for the fine-tuning with an offset shifting of the SONO-VARIO probe using the "Offset" parameter (see SONO-VIEW manual).

If the moisture values at the initial start-up of the SONO-VARIO deviates more than +-1% to the kiln dried moisture values, this can be due to the following causes:

1. The installation of the probe under the silo valve could be not good or correct. The probe surface must be completely covered with sand/gravel when the flap is opened. A good and stable material flow must be ensured. **A recording of a video during the batch process can be very helpful for analysis.**
2. An incorrect calibration curve could be set in the SONO-VARIO. The SONO-VARIO is delivered with the universal calibration curve Cal1 for sand and gravel.
3. A wrong scaling factor could be set in the PLC. In the SONO-VARIO, a moisture range of 0 to 20% corresponds to the current output of 0 (4) .. 20mA. The 0-20% moisture scaling factor must also be entered in the PLC. **Please contact your control manufacturer.**
For Command-Alkon control systems, special parameters must be set in the PLC as well as in the SONO-VARIO (info letter on request!).
4. For special sands (e.g., fine sand), a 2-point calibration may be required in the PLC or in the SONO-VARIO (see SONO-VARIO manual and SONO-VIEW manual).
5. For gravel and split, limit settings must be entered in the PLC, since flowing water in gravel or split leads to a too high moisture value result in the SONO-VARIO. **Please contact your control manufacturer.**
6. Sometimes it may be necessary to check the moisture value displayed in the PLC. Not infrequently, the measured value processing in the PLC is faulty. To check this, connect the SONO-VARIO to the SONO-VIEW display module and check or compare the moisture value displayed in the PLC with the moisture value displayed in the SONO-VIEW.
Attention: The operating mode CH in the SONO-VARIO must then be set to CC mode for a test run and later reset to mode CH again.
7. Check start / stop conditions in the PLC.
Start condition: Time in seconds or weight in Kg in the scale.
Stop condition: usually % of the target weight.
Please contact your control manufacturer.

If none of the problems outlined here can be solved, the IMKO service is available for you with the bookable service package.

6.9. Exchange of the Probe Head of the VARIOxtrem

At the SONO-VARIOxtrem not only the ceramic plate but the whole metal/ceramic wear-resistant probe head can be exchanged.

This is how easy it is to exchange the wear-resistant probe head:

- Loosen the 4 fastening screws (look for the right sequence of washer and gasket rings).
- Lift off the probe head carefully so that the robust spring contacts in the interior are canted as little as possible.
- Clean the surface inside the probe body for the O-Ring.
- Place the probe head so that the two spring contacts are inserted in the contact bushings.
- Screw the 4 fastening screws back on. It is to consider, that the 4 screws "find" the 4 holes in the green epoxy plate inside the probe.

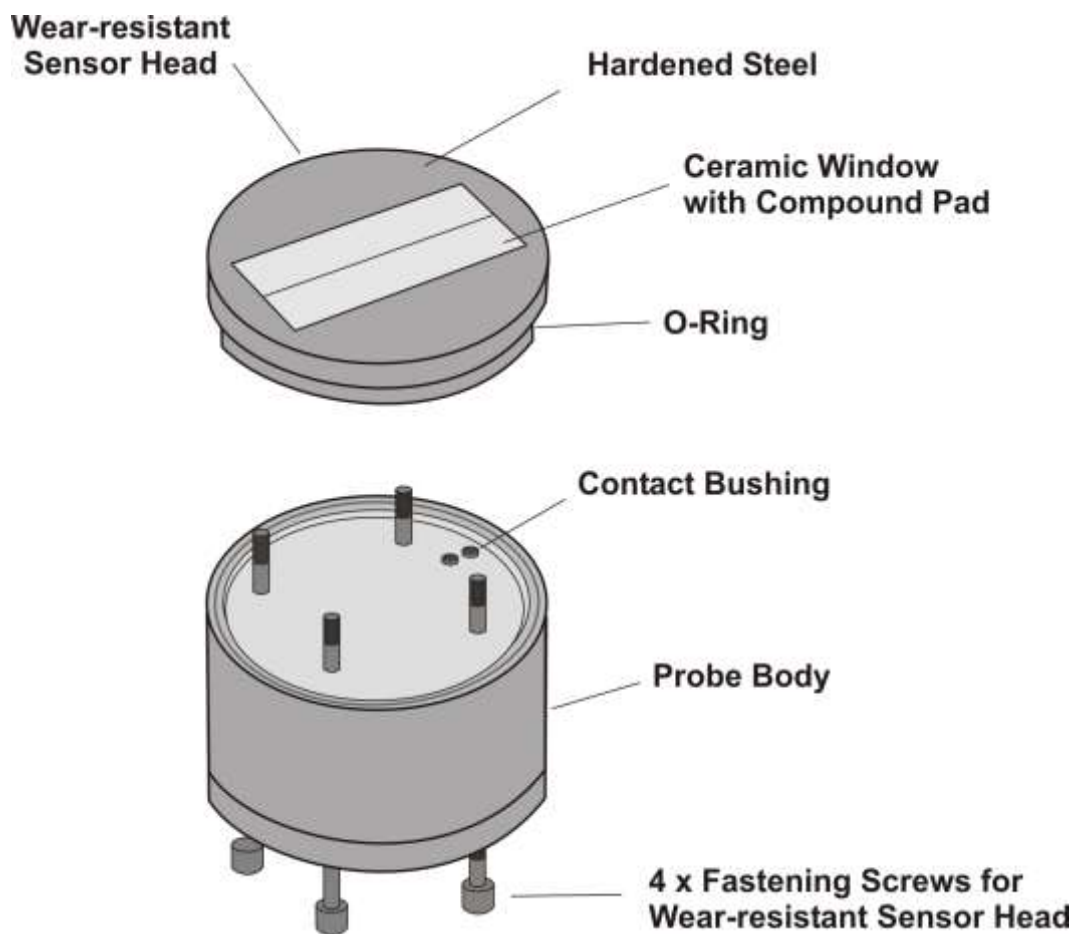

6.9.1. Basic Balancing of a new Probe Head

The probe heads are all identical and are manufactured to fit precisely. In spite of this fact, after an exchange, it is necessary to make a basic calibration in air and water, that SONO-VARIO_{Xtrem} measures precise and accurate with the new probe head. Therefore some work-steps are required.

Basic calibration procedure:

1. Provide a small container with water in which the probe head can be plunged in. For the first calibration point in air the **probe head must be completely dry**. If appropriate dry it with a towel.
2. Unplug the blind cap of the calibration connector and plug in the calibration connector.
3. Plug in the MIL-connector with power supply to the probe. The blue LED is on for 3 seconds and start with a slow blinking for the next 10 seconds preparation time for the first calibration point in air. Therefore the dry probe head must be free in air. When the LED is on continual for 5 seconds the first calibration point is completed in air.
4. Now the blue LED starts with a quicker blinking during 10 seconds preparation time for the second point in water. During this 10 seconds the probe head must be plunged in water. When the LED is on continual for 5 seconds the calibration is completed in water. After that the LED is off.
5. If the calibration should be failed, the blue LED will be blinking continual.
6. Unplug the MIL connector and the calibration connector. Plug in the blind cap of the calibration connector. Plug in the MIL connector again. The blue LED should be active continual now. SONO-VARIO is ready to use. With strong pressing of a hand to the probe head, the analogue moisture output 4..20mA should be respond.

If necessary the basic balancing procedure could be repeated several times.

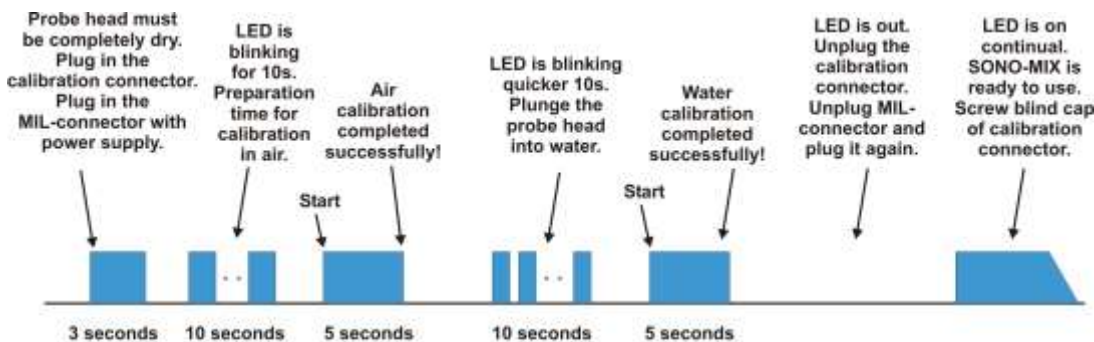

7. Serial Connection to the SM-USB Module from IMKO

The SM-USB provides the ability to connect a SONO probe either to the standard RS485 interface or to the IMP-Bus from IMKO. **In fact that the IMP-Bus is more robust and enables the download of a new firmware to the SONO probe, the SONO probes are presetted ex-factory to the IMP-Bus. So it is recommended to use the IMP-Bus for a serial communication.** Both connector ports are shown in the drawing below.

The SM-USB is signalling the status of power supply and the transmission signals with 4 LED's. When using a dual-USB connector on the PC, it is possible to use the power supply for the SONO probe directly from the USB port of the PC without the use of the external AC adapter.

Connection to the Probe:

RS485 Connector

Pin B: 0V Power Supply

Pin A: +12VDC Power Supply

Pin G: RS485B Lead Colour "brown"

Pin F: RS485A Lead Colour "white"

+12VDC

IMP-Bus Connector

With the option to accomplish a download of the firmware for the SONO probe

Pin B: 0V Power Supply

Pin A: +12VDC Power Supply

Pin C: (rt) Lead Colour "grey/pink"

Pin J: (com) Lead Colour "blue/red"

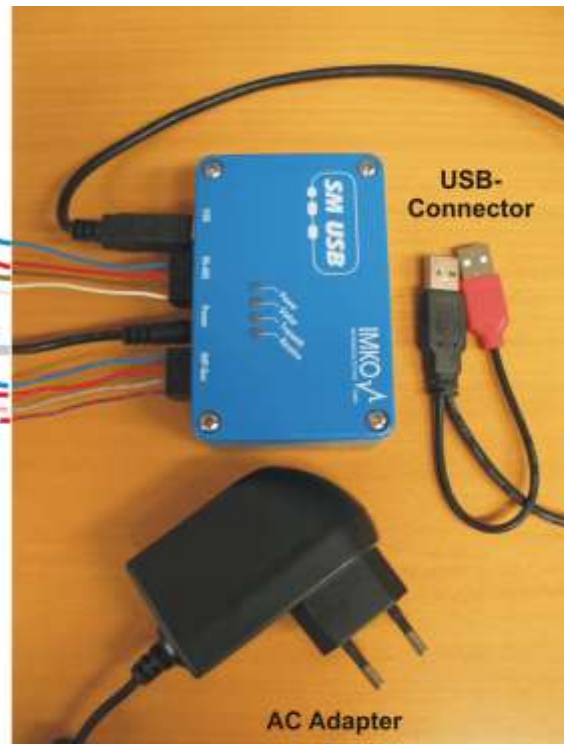

How to start with the SM-USB module from IMKO

- Install USB-Driver from USB-Stick.
- Connect the SM-USB to the USB-Port of the PC and the installation will be accomplished automatically.
- Install Software **SONOConfig-Setup.msi** from USB-Stick.
- Connection of the SONO probe to the SM-USB, with 4 wires for power supply and serial interface.
- Check the setting of the COM-Ports in the Device-Manager und setup the specific COM-Port with the Baudrate of 9600 Baud in SONO-CONFIG with the button "**Bus**" and "**Configuration**" (COM1-COM15 is possible).
- Start "**Scan probes**" in SONO-CONFIG.
- The SONO probe logs in the window „**Probe List**“ after max. 30 seconds with its serial number.

Note 1:

In the Device-Manager passes it as follows:

Control Panel → System → Hardware → Device-Manager

Under the entry “Ports (COM & LPT) now the item “USB Serial Port (COMx)” is found.

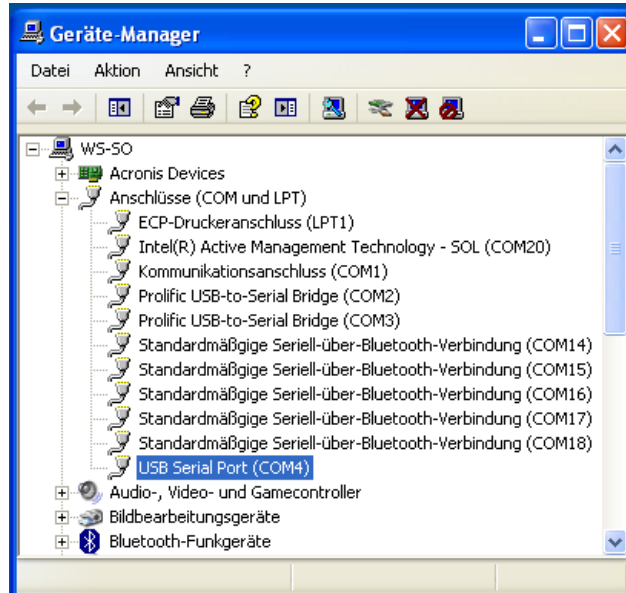

COMx set must be between COM1....COM9 and it should be ensured that there is no double occupancy of the interfaces.

If it comes to conflicts among the serial port or the USB-SM has been found in a higher COM-port, the COM port number can be adjusted manually:

By double clicking on "USB Serial Port" you can go into the properties menu, where you see "connection settings" – with "Advanced" button, the COM port number can be switched to a free number.

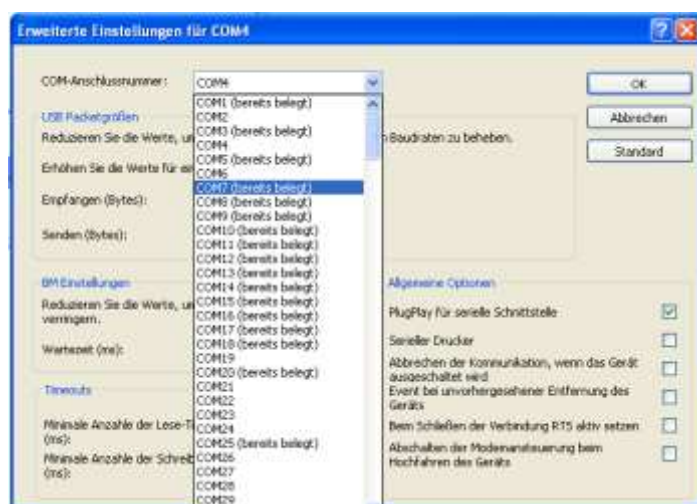

After changing the COMx port settings, SONO-CONFIG must be restarted.

8. Quick Guide for the Commissioning Software SONO-CONFIG

With SONO-CONFIG it is possible to make process-related adjustments of individual parameters of the SONO probe. Furthermore the measurement values of the SONO probe can be read from the probe via the serial interface and displayed on the screen.

In the menu "**Bus**" and the window "**Configuration**" the PC can be configured to an available COMx-port with the Baudrate of 9600 Baud.

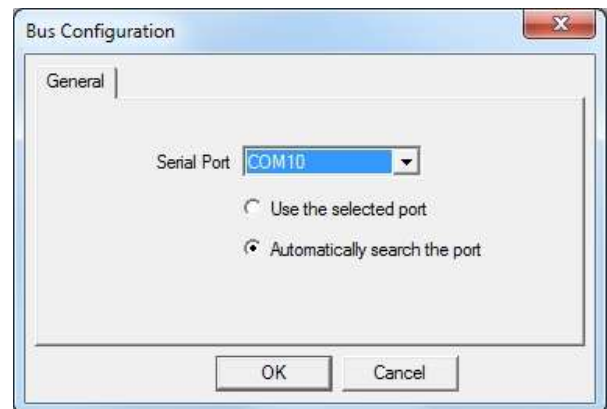
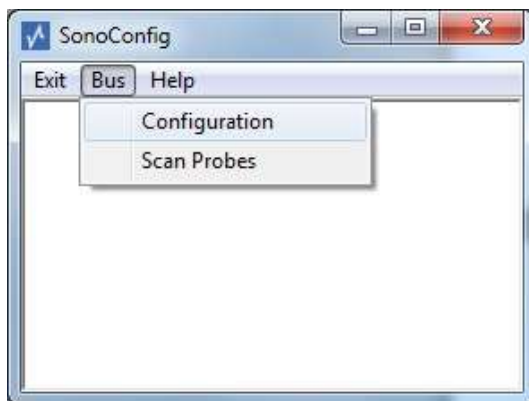

8.1.1. Scan of connected SONO probes on the serial interface

In the menu "**Bus**" and the window "**Scan Probes**" the serial bus can be scanned for attached SONO probes (takes max. 30 seconds).

SONO-CONFIG reports one or more connected and founded SONO probes with its serial number in the window "**Probe List**". One SONO probe can be selected by clicking.

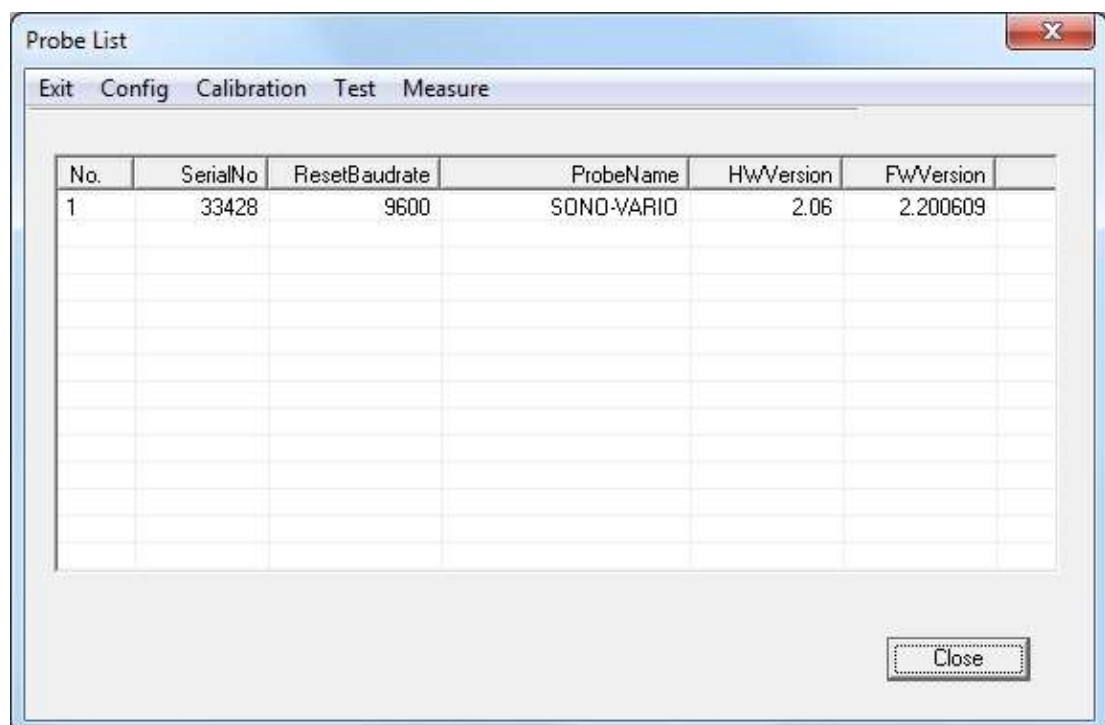

8.1.2. Configuration of serial SONO-interface

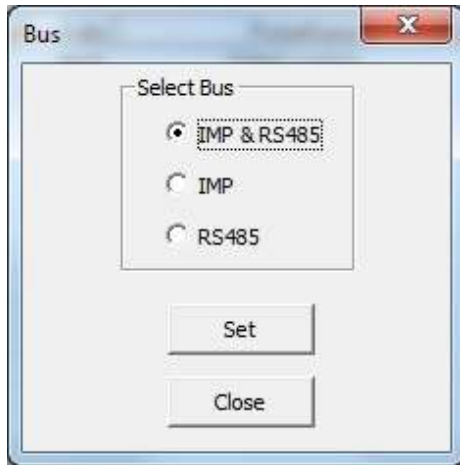

The serial interface inside the SONO probe can be selected to IMP-Bus or RS485. Due to very robust behavior it is recommended to select the IMP-Bus.

8.1.3. Set analogue outputs of the SONO probe

In the menu "**Config**" and the window "**Analog Output**" the two analogue outputs of the SONO probe can be configured (see Chapter "Analogue outputs..").

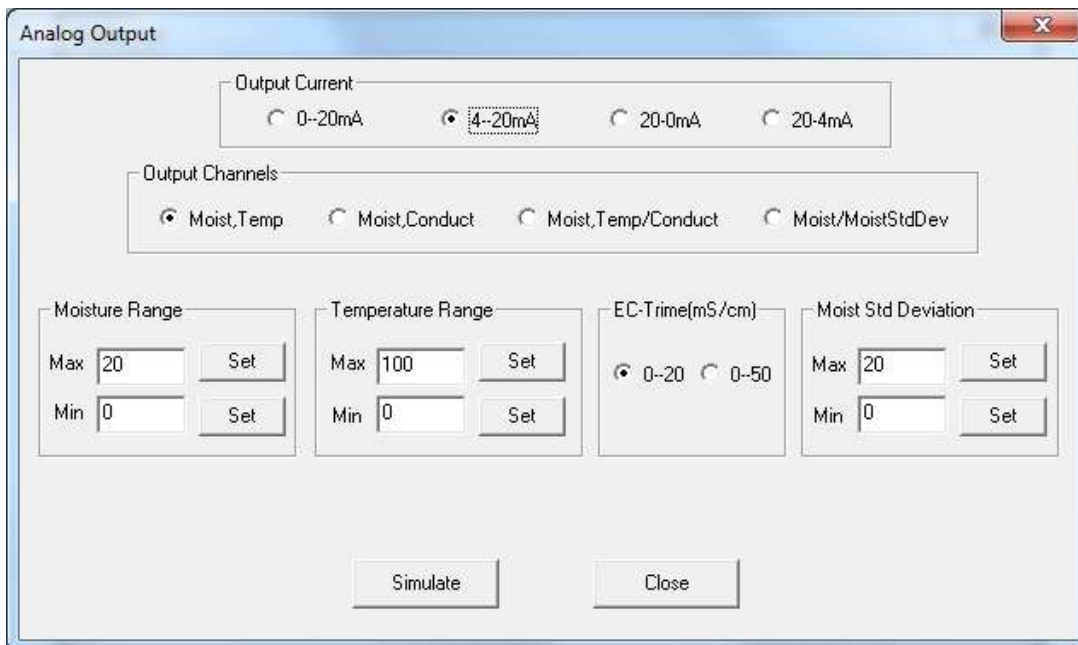

8.1.4. Configuration of Measure Mode

In "Probe List" with "Config" and "Measure Mode & Parameters" the SONO probe can be adjusted to the desired measure mode CA, CF, CS, CK, CC or CH (see Chapter "Configuration Measure Mode

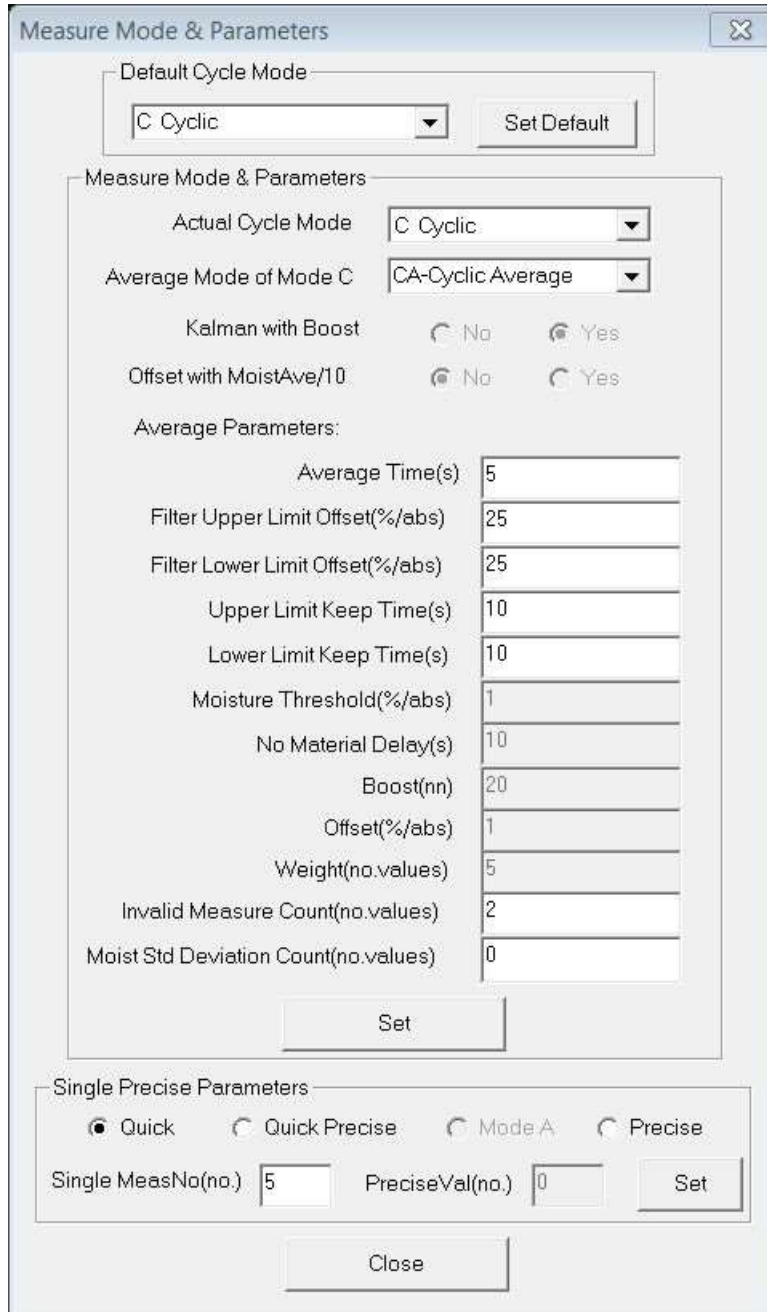

By selecting the operating mode, the SONO probe can be set up to different measurement modes, e.g. for averaging values from several single measurement values, for performing a filtering or performing other functions (see chapter "Measurement mode configuration" in this manual).

Furthermore, a SONO probe can be set to a special required precision of the single value measurement with "Single Precise Parameters". It is about settings, how the TDR radar pulse is executed and evaluated during one measurement cycle. The next chapter describes how this can be done.

8.1.5. Setting the precision of a single value measurement cycle

The SONO probe can be adjusted to the precision of a single value measurement via "**Single Precise Parameters**". First of all, the more accurate the SONO probe has to measure, the longer the time required for a single value measurement with a TDR radar pulse evaluation. There are applications where the SONO probe under a silo valve has only 2 to 4 seconds to perform several measurements with average value building. Here, a precise single value measurement would take too long, which is why the setting "**Quick**" with a shortest measuring time of 280 ms is recommended. Especially since the fluctuating flow of material under a silo valve cannot lead to constant conditions anyway in order to be able to carry out a highly precise individual measurement.

However, there are applications where it is necessary to achieve measuring accuracies up to $\pm 0.05\%$ moisture content which is only possible with very constant material conditions. E.g. in liquids with fractions of water in oil or in emulsions.

The following table provides an overview of the possible settings in the SONO probe for a single TDR radar pulse evaluation.

Parameter Setting	Measure-Mode	Function of the parameter	Application
Quick:	Mode C e.g. CS, CH, CF, etc.	Very quick TDR pulse search and very quick measurement within 280 ms.	e.g. under a silo flap with only 2-4 seconds measurement time.
Quick Precise:	Mode C e.g. CS, CH, CF, etc.	Quick and precise TDR pulse search and precise measurement within 350ms.	Similar to „Quick“ but with a little longer reaction time in process measurements.
Mode A:	Mode A	Mode A only with measurements via serial interface of the sensor. E.g. for calibrations.	Mode A for mobile moisture probes with hand measurement device HD2 or SONO-DIS.
Precise: PreciseVal: Input value: 1...4	Mode C <u>and</u> Mode A	Most precise single value measurement with precise TDR radar pulse triggering and pulse analysis. The higher the value 1 to 4 the higher the precision but the longer the measurement time.	Only in process environment where a continuously material flow is guaranteed and a very high precision is necessary.
Single MeasNo Default value: 4 Input value max. 10	Mode C <u>and</u> Mode A	Additional averaging of the single value measurement. Please consider: when 10 is entered, one single measurement can take up to one second.	Only in process environment where a continuously material flow is guaranteed and a very high precision is necessary.

8.1.6. Selection of the individual Calibration Curves

In the menu "**Calibration**" and the window "**Material Property Calibration**" the calibration curves CAL1 to Cal15 which are stored in the SONO probe are loaded and displayed on the screen (takes max. 1 minute). With the mouse pointer individual calibration curves can be activated and tested with the SONO-probe by activating the button "**Set Active Calib**". Furthermore, the individual calibration curves CAL1 to Cal15 can be adapted or modified with the calibration coefficients (see Chapter "**Creating a linear calibration curve**").

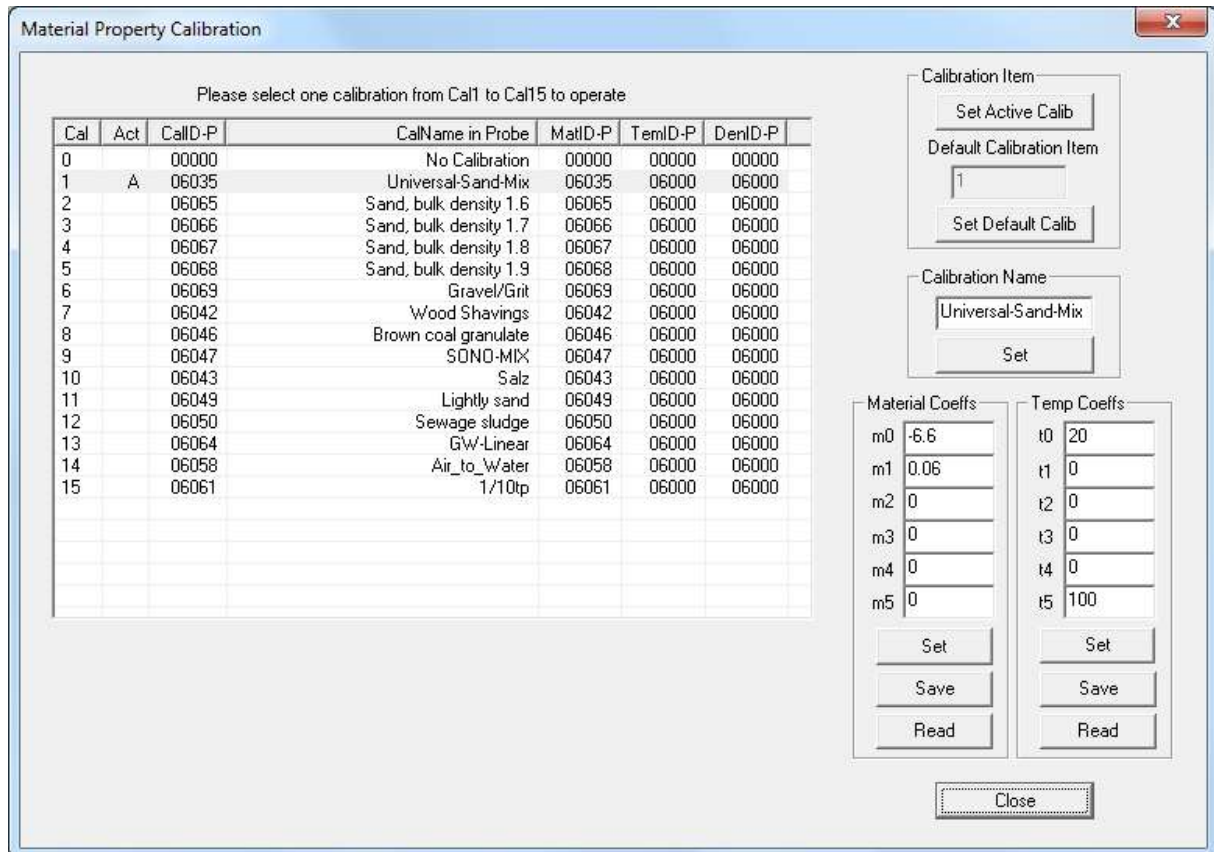

Cal	Act	CalID-P	CalName in Probe	MatID-P	TempID-P	DenID-P
0		00000	No Calibration	00000	00000	00000
1	A	06035	Universal-Sand-Mix	06035	06000	06000
2		06065	Sand, bulk density 1.6	06065	06000	06000
3		06066	Sand, bulk density 1.7	06066	06000	06000
4		06067	Sand, bulk density 1.8	06067	06000	06000
5		06068	Sand, bulk density 1.9	06068	06000	06000
6		06069	Gravel/Grit	06069	06000	06000
7		06042	Wood Shavings	06042	06000	06000
8		06046	Brown coal granulate	06046	06000	06000
9		06047	SONO-MIX	06047	06000	06000
10		06043	Salz	06043	06000	06000
11		06049	Lightly sand	06049	06000	06000
12		06050	Sewage sludge	06050	06000	06000
13		06064	GW-Linear	06064	06000	06000
14		06058	Air_to_Water	06058	06000	06000
15		06061	1/10tp	06061	06000	06000

The desired and possibly altered calibration curve (Cal1 . .15) which is activated after switching on the probes power supply can be adjusted with the button "**Set Default Calib**".

The calibration name can be entered in the window "Calibration Name".

The coefficients m0 to m1 (for linear curves) and m0 to m5 (for non-linear curves) can be entered and adjusted directly by hand with the buttons "**Set**" and "**Save**". Possible are non-linear calibration curves with polynomials up to fifth order (m0-m5).



Attention: Use "dot" as separator not comma, for coefficients m0 to m5 !

Determination of the parameters m0 and m1 for a linear calibration curve (see also chapter "Creating a linear calibration curve...")

1. Download the Excel-Sheet „SONO_LinearCalibration_Calculation“ from IMKO’s Homepage in the dropdown menu „Support Software“.
2. Enter into the Excel-Sheet both TP-values with the respective reference moisture values.
3. Read out both parameters m0 and m1 from the Excel-Sheet.
4. Enter, set and save both parameters m0 and m1 in the selected calibration curve.

8.1.8. Test run in the respective Measurement Mode

In the menu "Test" and the window "Test in Mode CA to CF" the measured moisture values "MoistAve" (Average) of the SONO probe are displayed on the screen and can be parallel saved in a file. In the menu "Test" and the window "Test in Mode CS" the measured single measurement values "Moist" (5 values per second) of the SONO probe are displayed on the screen and parallel stored in a file. In „Test in Mode A“ single measurement values (without average) are displayed on the screen and can also be stored in a file.



Attention: for a test run in mode CA, CH, CC, CF, CS or A it must be ensured that the SOI probe was also set to this mode (Measure Mode CA, CF, CS, A). If this is not assured, the probe returns zero values.

No.	Time	Date	MoistAve	MatTemp	EC-TRIME	TDRave	DeltaCnt	tpAve	Moist1	Moist2	Moist3	Moist4	TDR1	TDR2	TDR3	TDR4
1	10:34:41	25-06-2015	5.00	23.70	0.18	84.52	2	193.46	4.94	4.99	-1.00	-1.00	84.5	84.5	-1.0	84.5
2	10:34:40	25-06-2015	4.99	23.70	0.18	84.52	3	193.30	5.09	5.09	4.89	-1.00	84.5	84.5	84.6	84.5
3	10:34:39	25-06-2015	4.98	23.70	0.17	84.56	3	193.20	4.95	4.94	4.94	-1.00	84.6	84.5	84.5	84.5
4	10:34:38	25-06-2015	5.01	23.70	0.15	84.60	2	193.63	4.98	5.11	-1.00	-1.00	84.6	84.6	-1.0	84.5
5	10:34:37	25-06-2015	5.00	23.70	0.16	84.58	3	193.49	5.14	4.96	4.87	-1.00	84.6	84.6	84.6	84.5
6	10:34:36	25-06-2015	4.97	23.70	0.16	84.58	3	192.95	4.89	4.96	5.09	-1.00	84.6	84.6	84.5	84.5
7	10:34:35	25-06-2015	4.92	23.70	0.17	84.54	2	192.17	4.89	5.02	-1.00	-1.00	84.6	84.6	-1.0	84.5
8	10:34:34	25-06-2015	4.94	23.70	0.18	84.52	3	192.47	4.94	4.96	4.81	-1.00	84.5	84.5	84.5	84.5
9	10:34:33	25-06-2015	4.97	23.70	0.17	84.56	3	193.00	4.97	4.95	5.05	-1.00	84.6	84.6	84.5	84.5
10	10:34:32	25-06-2015	4.97	23.70	0.17	84.54	2	192.93	4.95	4.96	-1.00	-1.00	84.5	84.6	-1.0	84.5
11	10:34:31	25-06-2015	4.96	23.70	0.18	84.52	3	192.66	5.07	4.80	5.08	-1.00	84.5	84.6	84.5	84.5
12	10:34:30	25-06-2015	4.88	23.70	0.17	84.56	3	191.60	4.87	4.84	4.99	-1.00	84.6	84.5	84.5	84.5
13	10:34:29	25-06-2015	4.91	23.70	0.17	84.56	2	191.99	4.87	4.89	-1.00	-1.00	84.6	84.6	-1.0	84.5
14	10:34:28	25-06-2015	4.93	23.70	0.18	84.52	3	192.20	4.92	4.85	5.04	-1.00	84.5	84.5	84.6	84.5
15	10:34:27	25-06-2015	4.90	23.70	0.17	84.54	3	191.84	4.96	4.99	4.84	-1.00	84.6	84.5	84.5	84.5
16	10:34:26	25-06-2015	4.91	23.70	0.17	84.54	2	192.05	4.85	4.89	-1.00	-1.00	84.5	84.6	-1.0	84.5
17	10:34:25	25-06-2015	4.93	23.70	0.17	84.54	3	192.30	4.93	4.94	4.98	-1.00	84.5	84.5	84.6	84.5
18	10:34:24	25-06-2015	4.88	23.70	0.17	84.56	3	191.39	4.98	4.96	4.85	-1.00	84.5	84.6	84.5	84.5
19	10:34:23	25-06-2015	4.84	23.70	0.16	84.58	2	190.86	4.73	4.87	-1.00	-1.00	84.6	84.6	-1.0	84.5
20	10:34:22	25-06-2015	4.88	23.70	0.17	84.54	9	191.46	4.87	4.83	4.82	-4.95	84.6	84.5	84.6	84.5

Following measurement values are displayed on the screen:

- MoistAve** Moisture Value in % (Average)
- MatTemp** Temperature
- EC-TRIME** Radar-based-Conductivity EC-TRIME in dS/m (or mS/cm)
- TDRave** TDR-Signal-Level for special applications.
- DeltaCount** Number of single measurements which are used for the averaging.
- tpAve** Radar time (average) which corresponds to the respective moisture value.

By clicking „Save“ the recorded data is saved in a text file in the following path:
\SONO-CONFIG.exe-Pfad\MD\Dateiname

The name of the text file **Statis+SN+yyymmddHHMMSS.sts** is assigned automatically with the serial number of the probe (SN) and date and time. The data in the text file can be evaluated with Windows-EXCEL.

8.1.9. "Measure" Run in Datalogging-Operation

In the menu "Datalogging" it is possible to acquire and store measurement data from several SONO probes with variable and longer cycle rates in a datalogger-operation, e.g. to store measurement data during a long-term drying cycle.

8.1.10. Basic Balancing in Air and Water

SONO probe heads are identical and manufactured precisely. After an exchange of a probe head it is nevertheless advisable to verify the calibration and to check the basic calibration and if necessary to correct it with a "Basic Balancing".

With a "Basic Balancing" two reference calibration measurements are to be carried out with known set-points ("RefValues"). For the reference media, different calibration materials are used, dependent on the SONO probe type. For SONO probes with a ceramic measurement window, air and water (tap water) is used. For other SONO probes like SONO-GS1 glass beads are used for basic calibrations (on request).



Attention: Before performing a "Basic Balancing" it must be ensured that the SONO probe was set to "Measure Mode" A. If this is not assured, the probe returns zero values. After a "Basic Balancing" the SONO probe has to be set to "Measure Mode C" again, because otherwise the probe would not measure continuously!

In the menu "**Calibration**" and the window "**Basic Balancing**" the two set-point values of the radar time **tp** are displayed with 60ps and 1000ps.

1. Reference set-point A: **tp**=60ps in air (the surface of the probe head must be dry!!)
The first set-point can be activated with the mouse pointer by clicking to No.1. By activating the button "**Do Measurement**" the SONO probe determines the first reference set-point in air. In the column „MeasValues“ the measured raw value of the radar time **t** is displayed (e.g. 1532.05 picoseconds).
2. Reference set-point B: **tp**=1000ps in water. The SONO probe head has to be covered with water in a height of about 50mm. The second set-point can be activated with the mouse pointer by clicking to No.2. By activating the button "**Do Measurement**" the SONO probe determines the second reference set-point in water. In the column „MeasValues“ the measured raw value of the radar time **t** is displayed.
3. By activating the button „**Calculate Coeffs**“ and „**Coeffs → Probe**“ the alignment data is calculated automatically and is stored in the SONO probe non-volatile. With a "Test run" (in Mode A) the radar time **tp** of the SONO probe should be now 60ps in air and 1000ps in water.

Basic Balancing X

No	RefValues(tp)/ps	MoistValues[%]	MeasValues(t)/ps	Comments
1	60.0	0.0		air
2	1000.0	100.0		water

Coefficients	<Calculated>	<in File>	<in Probe>
b0			-1889.74
b1			1.24275

air and water

8.1.11. Offsetting the material temperature sensor

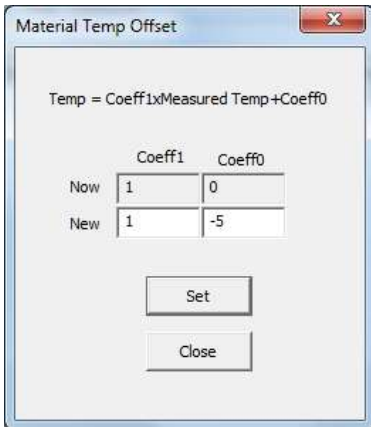

In the menu „**Calibration**“ and the window „**Material Temp Offset**“, a zero point offset can be adjusted for the material temperature sensor which is installed inside the SONO probe. In this example a temperature deviation of +5° C is produced by inside self-warming of the SONO probe. The correction value -5 can be set in the Coeff0 window.

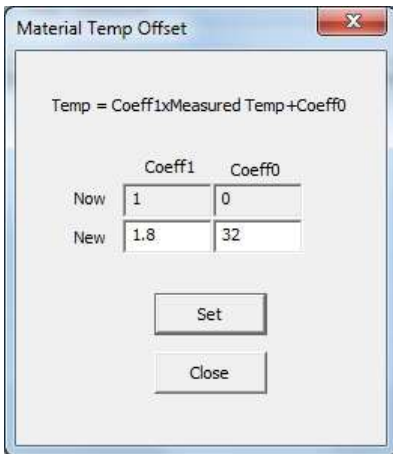

The example shows the parameters for displaying the temperature in the unit: Degree Fahrenheit.

8.1.12. Compensation of the electronic temperature

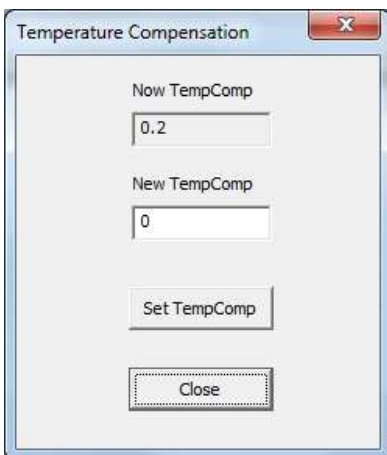

With this method of temperature compensation, a possible temperature drift of the SONO-electronic can be compensated. Because the SONO-electronic shows a generally low temperature drift, SONO probes are preset at delivery for standard ambient conditions with the parameter **TempComp**=0.2. Dependent on SONO probe type, this parameter TempComp can be adjusted for higher temperature ranges (up to 120°C for special high temperature version) to values up to **TempComp**=0.75. But it is to consider that it is necessary to make a Basic-Balancing of the SONO probe in air and water, if the parameter TempComp is changed to another value as TempComp=0.2. The parameter TempComp can be changed with the software tool SONO-CONFIG, in the menu "**Calibration**" and the window "**Electronic-Temperature-Compensation**".



Attention: When changing the TempComp parameter, a new basic balancing of the SONO probe is necessary!

9. Technical Data SONO-VARIO

SENSOR DESIGN

Casing: High Grade Steel V2A 1.4301

SONO-VARIOStandard: The probe head surface consists of stainless steel with abrasion-resistant aluminium oxide ceramic.

SONO-VARIOXtrem: The probe head surface consists of hardened steel with highly abrasion-resistant Si3O4 ceramic.

On request: Available are high-temperature versions of the SONO-VARIO up to 150°C with external measurement transformer SONO-ES.

MOUNTING

Sensor Dimensions:

SONO-VARIOStandard: 108 x 45mm (diameter x length)

SONO-VARIOXtrem: 108 x 71mm (diameter x length)

The mounting flange can be screwed on to the rear side of any container, hopper or silo.

MEASUREMENT RANGE MOISTURE

The sensor measures from 0% up to the point of material saturation. Measurement ranges up to 100% moisture (pure water) are possible with a special calibration.

MEASUREMENT RANGE CONDUCTIVITY

The sensor, as a material-specific characteristic value, delivers the radar-based conductance (EC-TRIME) in a range of 0...12dS/m. The conductivity range is reduced in moisture measurement ranges >50%.

MEASUREMENT RANGE TEMPERATURE

Measurement range: 0°C ...70°C

The temperature is measured 3mm beneath the wear-resistant sensor head inside the sensor casing and is issued at the analogue output 2. The material temperature can be measured with an external calibration and compensation of the sensor intrinsic-heating.

On request: High temperature version with external measurement transformer SONO-ES

MEASUREMENT DATA-PREPROCESSING

MEASUREMENT MODE CA: (Cyclic-Average) For relative short measuring processes with continual average value, filtering and an accuracy of up to 0.1%

MEASUREMENT CF: (Cyclic-Float-Average) For very slow measuring processes with floating average value, filtering and an accuracy of up to 0.1%

MEASUREMENT MODE CS: (Cyclic-Successive) For very short measuring processes without floating average and without filtering with internal up to 100 measurements per second and a cycle time of 200 milliseconds at the analogue output.

Mode CC: (Cyclic Cumulated) with automatic summation of a moisture quantity during one batch process.

Mode CH: (Cyclic Hold) with filtering functions, similar to Mode CC but without summation.

Mode CK: (Cyclic-Kalman-Filter with Boost) Standard setting for SONO-MIX for use in fresh concrete mixer with continual average value with special dynamic Kalman filtering and an accuracy of up to 0.1%.

ANALOGUE OUTPUT

2 x Analogue Outputs 0(4)...20mA

Analogue Output 1: Moisture in % (e.g. 0..20% variably adjustable)

Analogue Output 2: Conductivity (EC-TRIME) 0..20dS/m, or optionally the temperature, or optionally the standard deviation.

In addition, there is the option to split the analogue output 2 into two ranges: into 4..11mA for the temperature and 12..20mA for the conductivity. The analogue output 2 hereby changes over into an adjustable 5 second cycle between these two (current) measurement windows.

The two analogue outputs can be variably aligned with the SONO-CONFIG software. For a 0-10V DC voltage output, a 500R resistor can be installed.

CALIBRATION

The sensor is provided with a universal calibration for sand. A maximum of 15 different calibrations can be stored. For special materials, variable calibrations with polynomials up to the 5th order are possible. A zero point correction can be performed easily with the SONO-CONFIG software.

COMMUNICATION

The serial interface enables network operation of the probe, whereby a data bus protocol for the connection of several SONO probes to the serial interface is implemented by default. The connection of the probe to industrial busses such as Profibus, Ethernet, etc. is possible via optional external gateway modules (available upon request).

POWER SUPPLY

+12V to max. +24V-DC, 3W

Attention: Do not use unstabilized power supplies. Risk of overvoltage !

AMBIENT CONDITIONS

0 - 70°C

On request: High temperature version with external measurement transformer SONO-ES.

MEASUREMENT FIELD EXPANSION

SONO-VARIOStandard/Xtrem: Approximately 30 - 50 mm, depending on material and moisture.

CONNECTOR PLUG

The sensor is equipped with a robust 10-pole MIL flange connector. Readymade connection cables with MIL connectors are available in cable lengths of 4m, 10m, or 25 m.

10. Safety Notes

In this documentation, text points are highlighted, which require special attention.



DANGER:

The Warning Triangle with the exclamation mark warns you against personal injury or property damage.

Intended Use

Sensors and measuring systems of IMKO GmbH may only be used for the purpose described, taking into account the technical data. Misuse **and use of the equipment** other than for its intended purpose **are not eligible**. The function and operational safety of a sensor or measuring system can only be guaranteed if the general safety precautions, national regulations and the special safety instructions in this operating manual are observed during use.

The moisture sensors and measuring systems of IMKO GmbH are used to measure moisture according to the measuring purpose and measuring range defined and defined in the technical data. Only adherence to the instructions described in the manual is regarded as intended use. The manual describes the connection, use and maintenance of IMKO sensors and IMKO measuring systems. Read the manual before connecting and operating a sensor or measuring system. The manual is part of the product and must be kept close to the sensor or measuring system.



Impairment of safety

The sensor or the measuring system has been designed and tested in accordance with EN 61010 safety regulations for electronic measuring instruments and has left the factory in a safe and safe condition. If the sensor or the measuring system can no longer be operated safely, it must be put out of operation and secured by means of marking before further commissioning. In case of doubt, the sensor or the measuring system must be sent to the manufacturer or his contractual partner for repair or maintenance.



Modifications

For safety reasons, it is not permitted to carry out any modifications or modifications to the sensor or the measuring system without the consent of the manufacturer. The opening of the sensor or hand-held meter, adjustment and repair work, as well as all maintenance work other than the work described in the manual may only be carried out by a specialist authorized by IMKO. The sensor or the measuring system must be disconnected from the power supply before installation or maintenance work. Do not open or repair the hand-held unit and the power supply!



Hazard Warnings

Danger due to improper operation. The sensor or the measuring system may only be operated by instructed personnel. The operating personnel must have read and understood the operating instructions.



Danger by electricity

The hand-held meter must not be immersed in water or other liquids. The sensor is insensitive to moisture contained in the typically measured products. Only connect the hand-held meter to a properly installed outlet with the supplied voltage supply cable, the voltage of which corresponds to the technical data. Make sure that the power outlet is well accessible, so that you can unplug the power supply quickly if necessary. Use only the adapter that is suitable for your outlet.

Only operate the meter with the supplied original accessories. If you need additional accessories or replacement, please contact the manufacturer.

Do not use the meter in following case:

- if the measuring instrument, sensor, plug-in power supply or accessories are damaged,
- the sensor or the measuring system does not operate as intended,
- the power cord or plug is damaged,
- the sensor or the measuring system has fallen down.

Unplug the power supply from the wall outlet in following case:

- if you do not use the sensor or the measuring system for an extended period of time,
- before cleaning, unpacking or changing the sensor or the measuring system,
- if you are working inside the sensor or measuring instrument, e.g. connect devices,
- if a fault occurs during operation,
- during thunderstorms.



Caution - Property damage

Ensure that there is a sufficient distance to strong heat sources such as heating plates, heating pipes. Disconnect the sensor or handheld device from other devices before relocating or transporting it. Disconnect the connectors on the device.

Do not use aggressive chemical cleaning agents, scouring agents, hard sponges or the like.

Precise Moisture Measurement

in industry, hydrology, forestry, agriculture, environmental and earth science, civil engineering, as well as individual applications!